

1902-20V1902-EU



SERIES VRF

Commercial Air Conditioners **2019**

Commercial Air Conditioner Division Midea Group

Add.: Midea Headquarters Building, 6 Midea Avenue, Shunde, Foshan, Guangdong, China

Postal code: 528311

Tel: +86-757-26338346 Fax: +86-757-22390205

cac.midea.com global.midea.com

Note: Product specifications change from time to time as product improvements and developments are released and may vary from those in this document.



Midea CAC

Midea CAC is a key division of the Midea Group, a leading producer of consumer appliances and provider of heating, ventilation and air conditioning solutions. Midea CAC has continued with the tradition of innovation upon which it was founded, and emerged as a global leader in the HVAC industry. A strong drive for advancement has created a groundbreaking R&D department that has placed Midea CAC at the forefront of a competitive field. Through these independent efforts and joint cooperation with other global enterprises, Midea has supplied thousands of innovative solutions to customers worldwide.

We have three production bases: Shunde, Chongqing and Hefei.

MCAC Shunde: 38 product lines focusing on VRF, Split Products, Heat Pump Water Heaters, and AHU/FCU.

MCAC Chongqing: 14 product lines focusing on Water Cooled Centrifugal/Screw/Scroll Chillers, Air Cooled Screw/Scroll Chillers, and AHU/FCU.

MCAC Hefei: 11 product lines focusing on VRF, Chillers, and Heat Pump Water Heaters.

MIDEA GROUP
FORTUNE GLOBAL
FORTUNE
500

- 2017-2018 >> Launched the All DC Inverter V6 VRF globally, leading in VRF market
- 2016 >> Acquired 80% stake in Clivet
- 2014-2015 >> Win FIFA World Cup Stadiums project in Brazil Beira Rio, Olympic Games Stadiums project in Brazil Rio de Janeiro and Africa games Stadiums project in Congo Brazzaville successively
- 2014 >> Launched the All DC Inverter V5X globally, outstanding product performance helps Midea leading VRF market
- 2011-2014 >> Launched the DC Inverter V4 Plus Series successively, complete product lines help Midea successfully enter the mainstream VRF market
- 2011-2012 >> J.V. with Carrier LA and Carrier India successively
- 2009 >> Launched the DC Inverter V4 globally
- 2008 >> Developed DC inverter technology with Toshiba
- 2000-2001 >> Cooperated with Toshiba and Copeland, enter VRF field
- 1999 >> Entered the CAC field



OUTDOOR UNITS

VRF V6 Series Heat Pump	09
-------------------------	----

INDOOR UNITS

One-way Cassette	31
Two-way Cassette	32
Compact Four-way Cassette	33
Four-way Cassette	34
Medium Static Pressure Duct	35
High Static Pressure Duct	36
Fresh Air Processing Unit	37
Wall Mounted Unit	38
Ceiling / Floor Unit	39
Floor Standing Unit	40
Console	42

CONTROL SOLUTIONS

Wireless Remote Controllers	47
Wired Controllers	51
Centralized Controllers	55
Data Converter	61
Network Control System	67
BMS Gateways	73
Accessories	81





HRV





Heat Recovery Ventilator	92
--------------------------	----

BRANCH JOINTS

Branch Joints	96
---------------	----

OUTDOOR UNIT LINEUP

HP	8	10	12	14	16	18	20	22	24	26	28	30	32
Appearance	 (with single fan)			 (with single fan)		 (with dual fans)		 (with dual fans)					
8	●												
10		●											
12			●										
14				●									
16					●								
18						●							
20							●						
22								●					
24									●				
26										●			
28											●		
30												●	
32													●
34			●					●					
36				●				●					
38					●			●					
40			●							●			
42							●	●					
44								● ●					
46								●	●				
48								●		●			
50								●			●		
52									● ●				

HP	8	10	12	14	16	18	20	22	24	26	28	30	32
Appearance	 (with single fan)			 (with single fan)		 (with dual fans)		 (with dual fans)					
54										●	●		
56											● ●		
58											●	●	
60											●		●
62												●	●
64												● ●	
66			●					●					●
68				●				●					●
70					●			●					●
72			●								●		●
74						●		●					●
76								● ●					●
78								●	●				●
80								●		●			●
82								●			●		●
84										● ●			●
86										●	●		●
88											● ●		●
90											●	●	●
92											●		● ●
94												●	● ●
96													● ● ●

INDOOR UNIT LINEUP

kW		1.8	2.2	2.8	3.6	4.5	5.6	7.1
Btu/h		5k	7k	9k	12k	15k	19k	24k
One-way Cassette		●	●	●	●	●	●	●
Two-way Cassette			●	●	●	●	●	●
Compact Four-way Cassette			●	●	●	●		
Four-way Cassette				●	●	●	●	●
Medium Static Pressure Duct			●	●	●	●	●	●
High Static Pressure Duct								●
Fresh Air Processing Unit								
Wall Mounted Unit			●	●	●	●	●	●
Ceiling / Floor Unit					●	●	●	●
Floor Standing Unit			●	●	●	●	●	●
Console			●	●	●	●		

Note: High static pressure duct 40/45/56kW units are available at the end of September, 2018.

8.0	9.0	10.0	11.2	12.5	14.0	16.0	20.0	25.0	28.0	40.0*	45.0*	56.0*
27k	30k	34k	38k	42k	48k	55k	68k	85k	96k	136k	154k	191k
●	●	●	●		●							
●	●		●		●							
●	●		●		●	●	●	●	●	●	●	●
				●	●		●	●	●			
●	●											
●	●		●		●							
●												

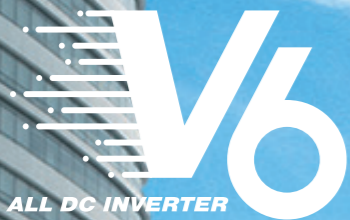

Series

OUTDOOR UNITS

11

3 Unique Innovations

12

High Efficiency

13

Wide Application Range

14

High Reliability

17

Enhanced Comfort

18

Easy Installation and Service



3 Unique Innovations

Energy Management System (EMS)

- **Floating refrigerant temperature to balance comfort and efficiency**

The evaporating temperature (in cooling) and condensing temperature (in heating) are automatically adjusted according to both indoor and outdoor temperature to maximize the comfort and energy efficiency.

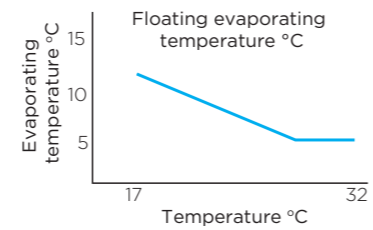

- **Output limitation during electricity supply restrictions**

With the integration of EMS, for projects with temporary electricity supply restrictions, V6 can be set to output 40-100% capacity.

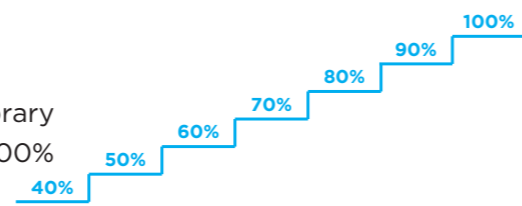

Enhanced Vapor Injection (EVI) Compressor

Thanks to the vapor injection DC inverter compressor, the V6 VRF can run heating mode stably down to -25°C, and the heating capacity can be improved greatly.

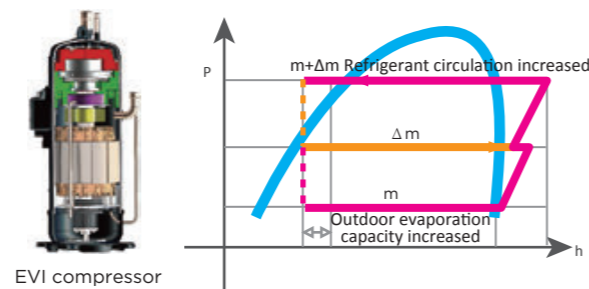

Triple Configurations

Triple (local/remote/network) configurations greatly simplified installation, commissioning and servicing.

- Field local configuration achieves quick and easy on-site settings, simplifies installation and commissioning.

- System checking and settings also can be easily achieved via wired and centralized controller, making the configuration more flexible and convenient.

- A desktop or laptop PC can be used for browser-based access to achieve system configurations through IMM Pro gateway via a LAN connection.



High Efficiency

Plate Heat Exchanger (PHE) Subcooling

Plate Heat Exchanger as a secondary intercooler boosts up refrigerant subcooling and improves 10% energy efficiency.

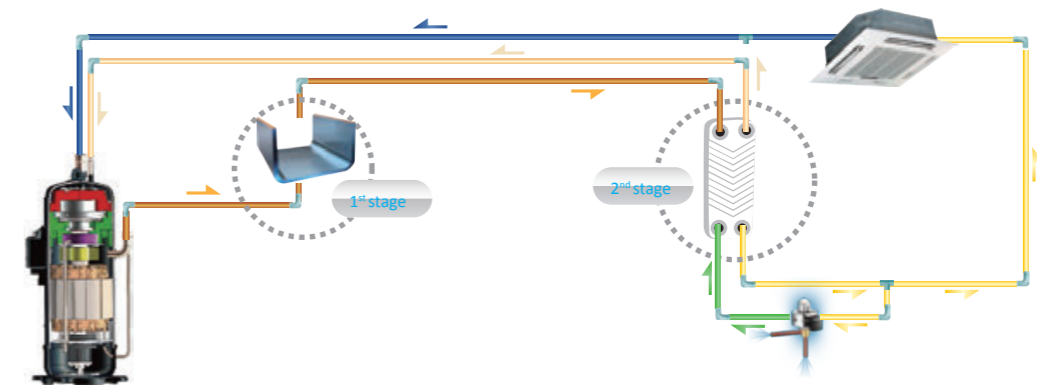

High Efficiency G-Type Heat Exchanger

24-32HP units use a high efficiency 3-row G-type heat exchanger with a heat exchange area 1.5 times that of the 22HP unit. The 24-32HP units also use super big size fan which diameter is up to 750mm.

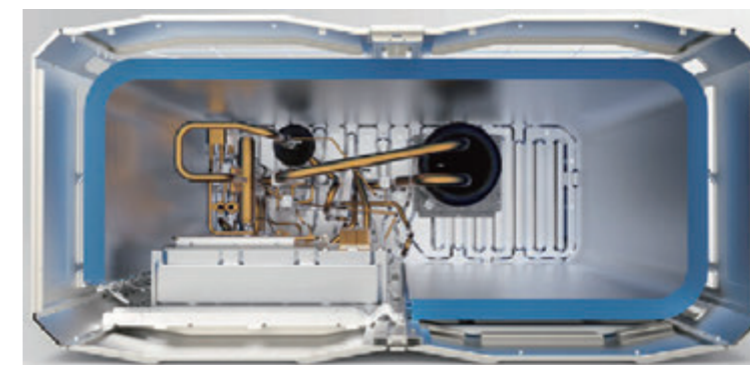

3-rows G-type heat exchanger

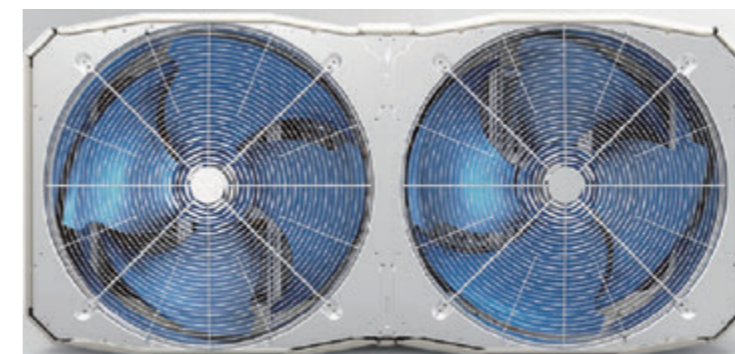

Super big size fan

Wide Application Range

Wide Capacity Range

Starting at 8HP, capacity increases in 2HP increments up to 96HP, which is the world's largest single-system VRF capacity.

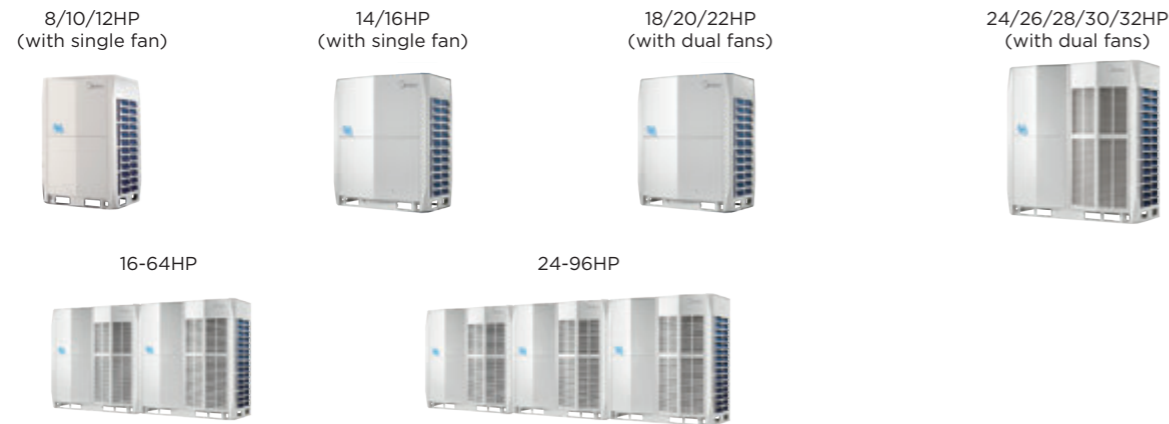

Wide Operation Range

The V6 VRF can operate stably in a wide ambient temperature range: from -5°C to 48°C in cooling mode and from -25°C to 24°C in heating mode.

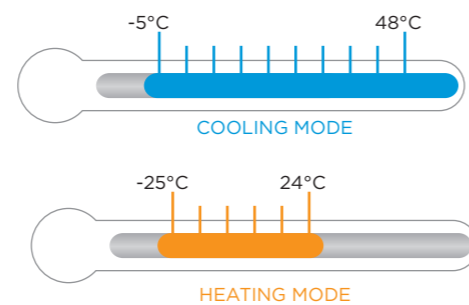

Long Piping Capability

- Total piping length: 1000m
- Longest piping length - actual (equivalent): 175m (200m)
- Longest piping length after first branch: 40/90*m
- Level difference between IDUs and ODU - ODU above (below): 90m (110m)
- Level difference between IDUs: 30m

*The longest length after rst branch is 40m as standard but can be extended to up to 90m under certain conditions. Please contact your local Midea dealer for further information.

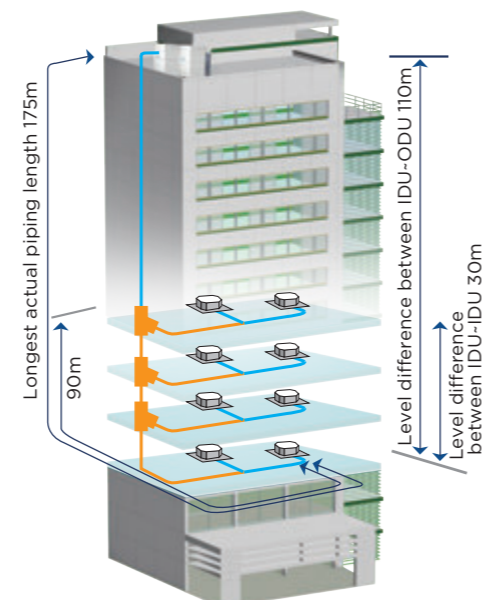

High Reliability

Duty Cycling

Duty cycling equalizes the running time of the outdoor units in a multiple-unit system and of the compressors in each unit, significantly extending compressor lifespan.

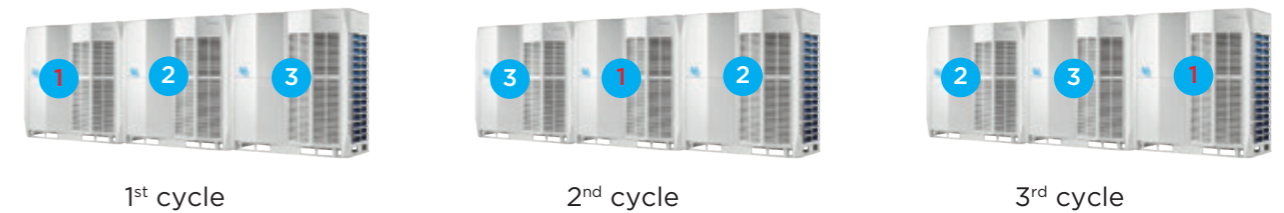

Precise Oil Control Technology

Four stages of oil control technology ensure all outdoor compressor oil is always kept at a safe level, eliminating any compressor oil shortage problems.

- Compressor internal oil separation.
- High-efficiency centrifugal oil separator (with separation efficiency of up to 99%) ensures that oil is separated from the discharge gas and returned to the compressors in a timely fashion.
- Oil balance pipes between compressors ensure even oil distribution to keep compressors running normally.
- Auto oil return program monitors the running time and system status to ensure reliable oil return.

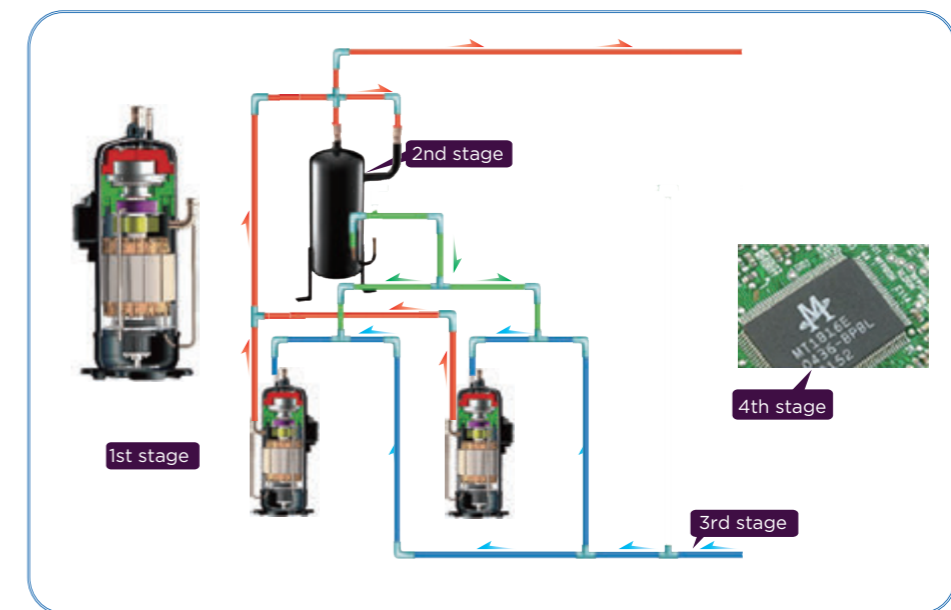

High Reliability

Backup Operation

In units with two compressors, if one compressor fails, the other compressor can run on its own for up to 4 days, allowing time for maintenance or repair whilst maintaining comfort.

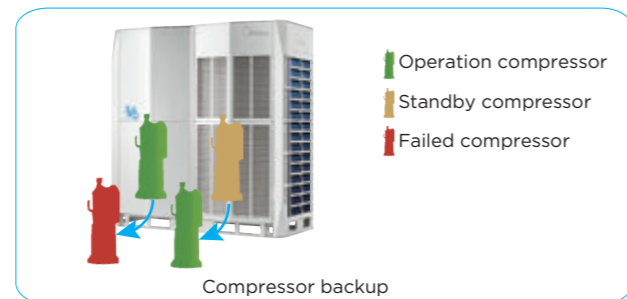

Anti-corrosion Protection

Outdoor units are given anti-corrosion treatment for non-extreme conditions as standard and can also be customized with heavy anti-corrosion treatment on main components for surface protection against corrosive air, acid rain and saline air (for installations in coastal regions) to extend overall useful life. The integrity of the anti-corrosion treatment is ensured by subjecting major components and parts to salt mist testing, moisture and heating testing and light aging testing.

- Fan motor**
Standard products: 72h of neutral salt mist
Heavy anti-corrosion products: 240h of neutral salt mist
- Painted sheet metal**
Standard products: 500h of neutral salt mist, 1000h of moisture and heating test, 500h of light aging test
Heavy anti-corrosion products: 1000h of neutral salt mist, 2000h of moisture and heating test, 720h of light aging test
- Screws / bolts / gaskets**
Standard products: 300h of neutral salt mist
Heavy anti-corrosion products: 720h of neutral salt mist
- Electric control box case**
Standard products: 96h of neutral salt mist
Heavy anti-corrosion products: 240h of neutral salt mist
- Heat exchanger aluminum foil**
Standard products: 72h of neutral salt mist
Heavy anti-corrosion products: 1000h of neutral salt mist, 140h of acid salt mis
- Heat exchanger copper pipe**
Standard products: 24h of neutral salt mist
Heavy anti-corrosion products: 120h of neutral salt mist

UL Anti-Corrosion Certificate

It has been certified by UL that our V6 VRF outdoor unit can withstand 27 years of simulated severe corrosion under a salt contaminated traffic environment.



High Reliability

Refrigerant Cooling PCB

The V6 VRF uses refrigerant cooling technology to cool the electric control box. It decreases the average temperature of electrical control components by about 8 degrees, guaranteeing the stable and safe running of the control system.

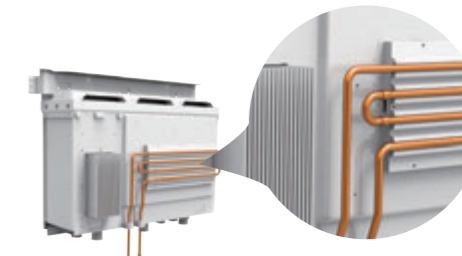

Real-time Refrigerant Amount Monitoring

The temperature and pressure of refrigerant can be real-time monitored by the outdoor unit. When the level of refrigerant is too low or too high, this can cause damage to the unit and poor performance. V6 outdoor unit can detect excessive or insufficient amounts of refrigerant, to ensure consistent performance.

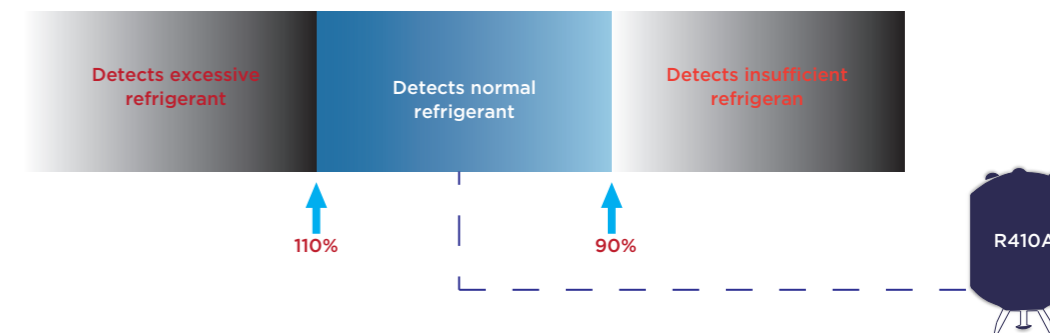

Auto Snow-blowing Function*

The innovatively designed auto snow-blowing function enables the outdoor unit to prevent the accumulation of snow by itself.

*This function is available as a customization option.



Dust-clean function*

The innovatively designed dust-clean function enables the outdoor unit to prevent the dust by itself.

*This function is available as a customization option.



Enhanced Comfort

Night Silent Mode

The night silent mode feature, which is easily configured on the outdoor unit's PCB, includes various scheduling options that can be used to reduce noise levels at times when low noise operation is required.

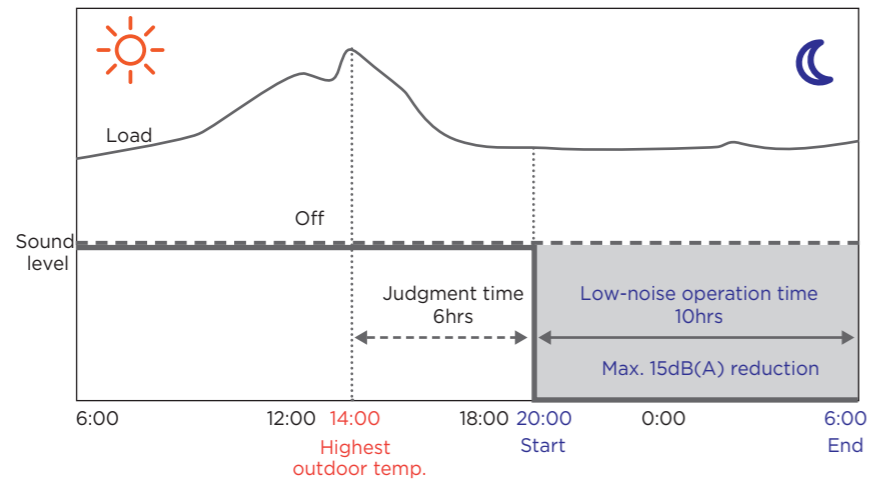

Enhanced Heating Capacity

Heating capacity is 100% of rated capacity at ambient temperatures as low as -5°C and 90% of rated capacity at -15°C.

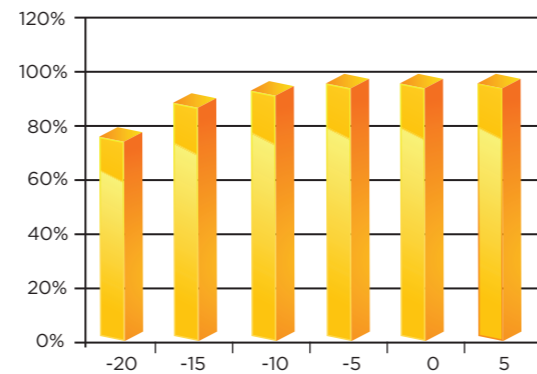

Intelligent Defrosting Technology

The intelligent defrosting program calculates the time required for defrosting according to the actual system status, eliminating heat losses from unnecessary defrosting. A specialized defrosting valve reduces time required for defrosting to as little as four minutes.

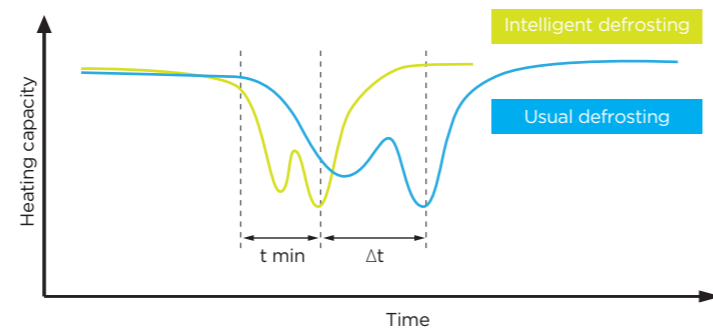

Easy Installation and Service

Non-polarized Communication Wiring*

Only one chain of 2-core non-polarized shielded communication wiring required for indoor and outdoor unit communication.

*In installations where relatively strong electromagnetic fields are present, 3-core shielded wiring should be used in order to prevent interference.

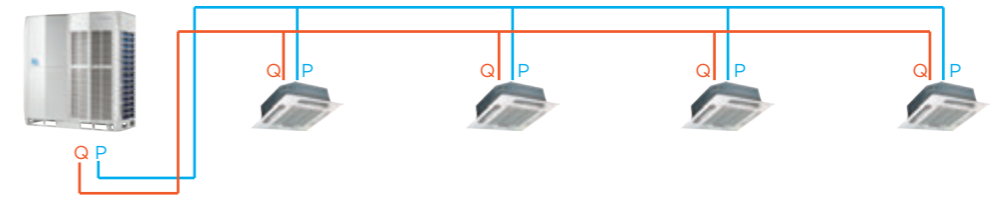

Auto Addressing

Outdoor units can distribute addresses to indoor units automatically. Remote and wired controllers can be used to query or modify each indoor unit's address.

Automatic Refrigerant Charging/Recycling Function*

Automatic refrigerant charging and recycling make installation and service easier and more efficient.

*This function is available as a customization option.

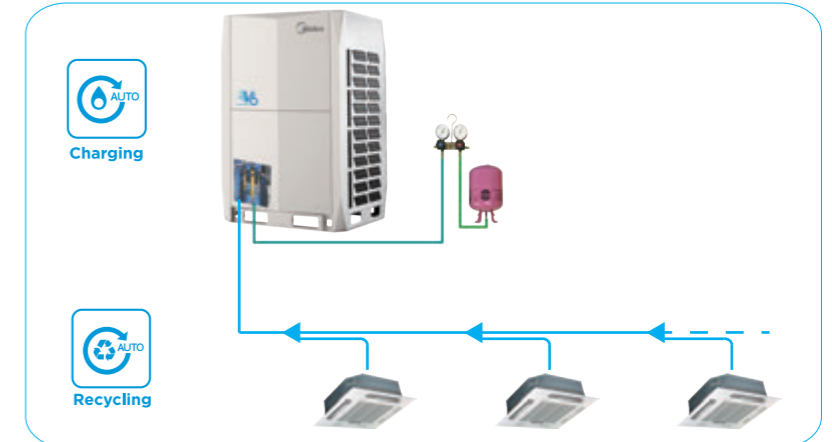

Optional Multifunctional PCB

An optional multifunctional small PCB can be installed on the unit's side columns, enabling installation and service engineers to activate Auto-commissioning or check the operating status without removing the front panel. It can also perform automatic data backup of the last 30 minutes' operating record.

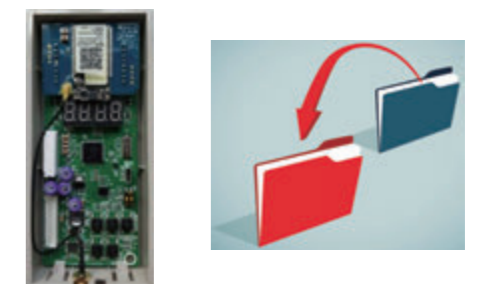

Specifications



Capacity		HP	8	10	12	14
Model			MV6-252WV2GN1-E	MV6-280WV2GN1-E	MV6-335WV2GN1-E	MV6-400WV2GN1-E
Power supply		V/Ph/Hz	380-415/3/50			
Cooling ¹	Capacity	kW	25.2	28.0	33.5	40.0
		kBut/h	86.0	95.5	114.3	136.5
	Power input	kW	5.93	6.75	8.7	9.9
	EER	kW/kW	4.25	4.15	3.85	4.05
Heating ²	Capacity	kW	25.2	28.0	33.5	40.0
		kBut/h	86.0	95.5	114.3	136.5
	Power input	kW	4.82	5.46	6.6	8.5
	COP	kW/kW	5.23	5.13	5.10	4.70
Connectable Indoor Unit	Total capacity	50-130% of outdoor unit capacity				
	Max. quantity	13	16	20	23	
Compressors	Type	DC inverter				
	Quantity	1				
Fan motors	Type	DC				
	Quantity	1				
	Max. ESP	Pa				
	20 Default; 60 Customize					
Refrigerant	Type	R410A				
	Factory charge	kg	11			13
Pipe connections ³	Liquid pipe	mm	Φ12.7		Φ15.9	Φ15.9
	Gas pipe	mm	Φ25.4		Φ28.6	Φ31.8
Airflow rate		m ³ /h	11000		13000	
Sound pressure level ⁴		dB(A)	58		60	62
Sound power level		dB(A)	78		81	85
Net dimensions (WxHxD)		mm	990×1635×790		1340×1635×850	
Packed dimensions (WxHxD)		mm	1090×1805×860		1405×1805×910	
Net weight		kg	227		277	
Gross weight		kg	242		304	
Ambient temp. operating range	Cooling	°C	-5 to 48			
	Heating	°C	-25 to 24			



Capacity		HP	16	18	20	22
Model			MV6-450WV2GN1-E	MV6-500WV2GN1-E	MV6-560WV2GN1-E	MV6-615WV2GN1-E
Power supply		V/Ph/Hz	380-415/3/50			
Cooling ¹	Capacity	kW	45.0	50.0	56.0	61.5
		kBut/h	153.5	170.6	191.1	209.8
	Power input	kW	12.0	12.5	15.1	18.4
	EER	kW/kW	3.75	4.00	3.70	3.35
Heating ²	Capacity	kW	45.0	50.0	56.0	61.5
		kBut/h	153.5	170.6	191.1	209.8
	Power input	kW	9.8	10.6	12.7	15.0
	COP	kW/kW	4.60	4.70	4.40	4.10
Connectable Indoor Unit	Total capacity	50-130% of outdoor unit capacity				
	Max. quantity	26	29	33	36	
Compressors	Type	DC inverter				
	Quantity	1				
Fan motors	Type	DC				
	Quantity	1				
	Max. ESP	Pa				
	20 Default; 60 Customize					
Refrigerant	Type	R410A				
	Factory charge	kg	13		17	
Pipe connections ³	Liquid pipe	mm	Φ15.9		Φ19.1	
	Gas pipe	mm	Φ31.8		Φ31.8	
Airflow rate		m ³ /h	13000		17000	
Sound pressure level ⁴		dB(A)	65		66	
Sound power level		dB(A)	88			
Net dimensions (WxHxD)		mm	1340×1635×850		1340×1635×825	
Packed dimensions (WxHxD)		mm	1405×1805×910			
Net weight		kg	277		348	
Gross weight		kg	304		368	
Ambient temp. operating range	Cooling	°C	-5 to 48			
	Heating	°C	-25 to 24			

Notes:

- Indoor temperature 27°C DB, 19°C WB; outdoor temperature 35°C DB; equivalent refrigerant piping length 7.5m with zero level difference.
- Indoor temperature 20°C DB; outdoor temperature 7°C DB, 6°C WB; equivalent refrigerant piping length 7.5m with zero level difference.
- Diameters given are those of the unit's stop valves.
- Sound pressure level is measured at a position 1m in front of the unit and 1.3m above the floor in a semi-anechoic chamber.

Specifications



Capacity		HP	24	26	28
Model			MV6-670WV2GN1-E	MV6-730WV2GN1-E	MV6-785WV2GN1-E
Power supply		V/Ph/Hz	380-415/3/50		
Cooling ¹	Capacity	kW	67.0	73.0	78.5
		kBut/h	228.6	249.1	267.8
	Power input	kW	18.1	20.9	24.2
	EER	kW/kW	3.70	3.49	3.25
Heating ²	Capacity	kW	67.0	73.0	78.5
		kBut/h	228.6	249.1	267.8
	Power input	kW	15.33	18.11	21.27
	COP	kW/kW	4.37	4.03	3.69
Connectable Indoor Unit	Total capacity	50-130% of outdoor unit capacity			
	Max. quantity	39	43	46	
Compressors	Type	DC inverter			
	Quantity	2			
Fan motors	Type	DC			
	Quantity	2			
	Max. ESP	Pa			
	20 Default; 60 Customize				
Refrigerant	Type	R410A			
	Factory charge	kg	22		
Pipe connections ³	Liquid pipe	mm	Φ19.1		Φ22.2
	Gas pipe	mm	Φ31.8		Φ31.8
Airflow rate		m ³ /h	25000		
Sound pressure level ⁴		dB(A)	67		68
Sound power level		dB(A)	89		90
Net dimensions (WxHxD)		mm	1730 × 1830 × 850		
Packed dimensions (WxHxD)		mm	1800×2000×910		
Net weight		kg	430		
Gross weight		kg	453		
Ambient temp. operating range	Cooling	°C	-5 to 48		
	Heating	°C	-25 to 24		



Capacity		HP	30	32
Model			MV6-850WV2GN1-E	MV6-900WV2GN1-E
Power supply		V/Ph/Hz	380-415/3/50	
Cooling ¹	Capacity	kW	85.0	90.0
		kBut/h	290.0	307.1
	Power input	kW	27.4	31.0
	EER	kW/kW	3.10	2.90
Heating ²	Capacity	kW	85.0	90.0
		kBut/h	290.0	307.1
	Power input	kW	23.0	25.7
	COP	kW/kW	3.70	3.50
Connectable Indoor Unit	Total capacity	50-130% of outdoor unit capacity		
	Max. quantity	50	53	
Compressors	Type	DC inverter		
	Quantity	2		
Fan motors	Type	DC		
	Quantity	2		
	Max. ESP	Pa		
	20 Default; 60 Customize			
Refrigerant	Type	R410A		
	Factory charge	kg	25	
Pipe connections ³	Liquid pipe	mm	Φ22.2	
	Gas pipe	mm	Φ38.1	
Airflow rate		m ³ /h	24000	
Sound pressure level ⁴		dB(A)	68	
Sound power level		dB(A)	90	
Net dimensions (WxHxD)		mm	1730 × 1830 × 850	
Packed dimensions (WxHxD)		mm	1800×2000×910	
Net weight		kg	475	
Gross weight		kg	507	
Ambient temp. operating range	Cooling	°C	-5 to 48	
	Heating	°C	-25 to 24	

Notes:

- Indoor temperature 27°C DB, 19°C WB; outdoor temperature 35°C DB; equivalent refrigerant piping length 7.5m with zero level difference.
- Indoor temperature 20°C DB; outdoor temperature 7°C DB, 6°C WB; equivalent refrigerant piping length 7.5m with zero level difference.
- Diameters given are those of the unit's stop valves.
- Sound pressure level is measured at a position 1m in front of the unit and 1.3m above the floor in a semi-anechoic chamber.

Specifications



Capacity	HP	34	36	38	40	
Model		MV6-950WV2GN1-E	MV6-1015WV2GN1-E	MV6-1065WV2GN1-E	MV6-1120WV2GN1-E	
Combination type		12HP+22HP	14HP+22HP	16HP+22HP	12HP+28HP	
Power supply	V/Ph/Hz	380-415/3/50				
Cooling ¹	Capacity	kW	95.0	101.5	106.5	112.0
		kBut/h	324.1	346.3	363.4	382.1
	Power input	kW	27.1	28.2	30.4	32.9
	EER	kW/kW	3.51	3.59	3.51	3.41
Heating ²	Capacity	kW	95.0	101.5	106.5	112.0
		kBut/h	324.1	346.3	363.4	382.1
	Power input	kW	21.6	23.5	24.8	27.87
	COP	kW/kW	4.40	4.32	4.30	4.02
Connectable Indoor Unit	Total capacity	50-130% of outdoor unit capacity				
	Max. quantity	56	59	63	64	
Compressors	Type	DC inverter				
	Quantity	3				
Fan motors	Type	DC				
	Quantity	3				
Refrigerant	Type	R410A				
	Factory charge	kg	11+17	13+17		11+22
Pipe connections ³	Liquid pipe	mm	Φ19.1		Φ19.1	
	Gas pipe	mm	Φ31.8		Φ38.1	
Airflow rate	m ³ /h	28000	30000		36000	
Sound pressure level ⁴	dB(A)	69				
Sound power level	dB(A)	91				
Net dimensions (WxHxD)	mm	(990×1635×790)+(1340×1635×825)	(1340×1635×850)+(1340×1635×825)		(990×1635×790)+(1730×1830×850)	
Packed dimensions (WxHxD)	mm	(1090×1805×860)+(1405×1805×910)	(1405×1805×910)×2		(1090×1805×860)+(1800×2000×910)	
Net weight	kg	227+348	277+348		227+430	
Gross weight	kg	242+368	304+368		242+453	
Ambient temp. operating range	Cooling	°C				
	Heating	°C				



Capacity	HP	42	44	46	48	
Model		MV6-1175WV2GN1-E	MV6-1230WV2GN1-E	MV6-1285WV2GN1-E	MV6-1345WV2GN1-E	
Combination type		20HP+22HP	22HP+22HP	22HP+24HP	22HP+26HP	
Power supply	V/Ph/Hz	380-415/3/50				
Cooling ¹	Capacity	kW	117.5	123.0	128.5	134.5
		kBut/h	400.9	419.7	438.4	458.9
	Power input	kW	33.5	36.7	36.5	39.3
	EER	kW/kW	3.51	3.35	3.52	3.43
Heating ²	Capacity	kW	117.5	123.0	128.5	134.5
		kBut/h	400.9	419.7	438.4	458.9
	Power input	kW	27.7	30.0	30.43	33.21
	COP	kW/kW	4.24	4.10	4.22	4.05
Connectable Indoor Unit	Total capacity	50-130% of outdoor unit capacity				
	Max. quantity	64				
Compressors	Type	DC inverter				
	Quantity	4				
Fan motors	Type	DC				
	Quantity	4				
Refrigerant	Type	R410A				
	Factory charge	kg	17×2		17+22	
Pipe connections ³	Liquid pipe	mm	Φ19.1		Φ19.1	
	Gas pipe	mm	Φ38.1		Φ38.1	
Airflow rate	m ³ /h	34000	34000		42000	
Sound pressure level ⁴	dB(A)	70				
Sound power level	dB(A)	92				
Net dimensions (WxHxD)	mm	(1340×1635×825)×2		(1340×1635×825)+(1730×1830×850)		
Packed dimensions (WxHxD)	mm	(1405×1805×910)×2		(1405×1805×910)+(1800×2000×910)		
Net weight	kg	348×2		348+430		
Gross weight	kg	368×2		368+453		
Ambient temp. operating range	Cooling	°C				
	Heating	°C				

- Notes:
- Indoor temperature 27°C DB, 19°C WB; outdoor temperature 35°C DB; equivalent refrigerant piping length 7.5m with zero level difference.
 - Indoor temperature 20°C DB; outdoor temperature 7°C DB, 6°C WB; equivalent refrigerant piping length 7.5m with zero level difference.
 - Diameters given are those for the pipe connecting the outdoor unit combination to the first indoor branch joint for systems with total equivalent liquid piping lengths of less than 90m. For systems with total equivalent liquid piping lengths of 90m or longer, please refer to the V6 Series Engineering Data Book for connection piping diameters.
 - Sound pressure level is measured at a position 1m in front of the unit and 1.3m above the floor in a semi-anechoic chamber.

Specifications



Capacity	HP	50	52	54	56	
Model		MV6-1400WV2GN1-E	MV6-1460WV2GN1-E	MV6-1515WV2GN1-E	MV6-1570WV2GN1-E	
Combination type		22HP+28HP	26HP+26HP	26HP+28HP	28HP+28HP	
Power supply	V/Ph/Hz	380-415/3/50				
Cooling ¹	Capacity	kW	140.0	146.0	151.5	157.0
		kBut/h	477.7	498.2	516.9	535.7
	Power input	kW	42.5	41.8	45.1	48.3
	EER	kW/kW	3.29	3.49	3.36	3.25
Heating ²	Capacity	kW	140.0	146.0	151.5	157.0
		kBut/h	477.7	498.2	516.9	535.7
	Power input	kW	36.37	36.22	39.38	42.54
	COP	kW/kW	3.85	4.03	3.85	3.69
Connectable Indoor Unit	Total capacity	50-130% of outdoor unit capacity				
	Max. quantity	64				
Compressors	Type	DC inverter				
	Quantity	4				
Fan motors	Type	DC				
	Quantity	4				
Refrigerant	Type	R410A				
	Factory charge	kg	17+22		22×2	
Pipe connections ³	Liquid pipe	mm	Φ19.1		Φ19.1	
	Gas pipe	mm	Φ38.1		Φ41.3	
Airflow rate	m ³ /h	42000	50000			
Sound pressure level ⁴	dB(A)	70				
Sound power level	dB(A)	92				
Net dimensions (WxHxD)	mm	(1340×1635×825)+(1730×1830×850)		(1730×1830×850)×2		
Packed dimensions (WxHxD)	mm	(1405×1805×910)+(1800×2000×910)		(1800×2000×910)×2		
Net weight	kg	348+430		430×2		
Gross weight	kg	368+453		453×2		
Ambient temp. operating range	Cooling	°C				
	Heating	°C				



Capacity	HP	58	60	62	64	
Model		MV6-1635WV2GN1-E	MV6-1685WV2GN1-E	MV6-1750WV2GN1-E	MV6-1800WV2GN1-E	
Combination type		28HP+30HP	28HP+32HP	30HP+32HP	32HP+32HP	
Power supply	V/Ph/Hz	380-415/3/50				
Cooling ¹	Capacity	kW	163.5	168.5	175.0	180.0
		kBut/h	557.9	574.9	597.1	614.2
	Power input	kW	51.6	55.2	58.5	62.1
	EER	kW/kW	3.17	3.05	2.99	2.90
Heating ²	Capacity	kW	163.5	168.5	175.0	180.0
		kBut/h	557.9	574.9	597.1	614.2
	Power input	kW	44.27	46.97	48.7	51.4
	COP	kW/kW	3.69	3.59	3.59	3.50
Connectable Indoor Unit	Total capacity	50-130% of outdoor unit capacity				
	Max. quantity	64				
Compressors	Type	DC inverter				
	Quantity	4				
Fan motors	Type	DC				
	Quantity	4				
Refrigerant	Type	R410A				
	Factory charge	kg	22+25		25×2	
Pipe connections ³	Liquid pipe	mm	Φ19.1		Φ19.1	
	Gas pipe	mm	Φ41.3		Φ41.3	
Airflow rate	m ³ /h	49000	48000			
Sound pressure level ⁴	dB(A)	70				
Sound power level	dB(A)	92				
Net dimensions (WxHxD)	mm	(1730×1830×850)×2				
Packed dimensions (WxHxD)	mm	(1800×2000×910)×2				
Net weight	kg	430+475		475×2		
Gross weight	kg	453+507		507×2		
Ambient temp. operating range	Cooling	°C				
	Heating	°C				

- Notes:
- Indoor temperature 27°C DB, 19°C WB; outdoor temperature 35°C DB; equivalent refrigerant piping length 7.5m with zero level difference.
 - Indoor temperature 20°C DB; outdoor temperature 7°C DB, 6°C WB; equivalent refrigerant piping length 7.5m with zero level difference.
 - Diameters given are those for the pipe connecting the outdoor unit combination to the first indoor branch joint for systems with total equivalent liquid piping lengths of less than 90m. For systems with total equivalent liquid piping lengths of 90m or longer, please refer to the V6 Series Engineering Data Book for connection piping diameters.
 - Sound pressure level is measured at a position 1m in front of the unit and 1.3m above the floor in a semi-anechoic chamber.

Specifications



Capacity	HP	66	68	70	72
Model		MV6-1850WV2GN1-E	MV6-1915WV2GN1-E	MV6-1965WV2GN1-E	MV6-2020WV2GN1-E
Combination type		12HP+22HP+32HP	14HP+22HP+32HP	16HP+22HP+32HP	12HP+28HP+32HP
Power supply	V/Ph/Hz	380-415/3/50			
Cooling ¹	Capacity	kW 185.0	kW 191.5	kW 196.5	kW 202.0
		kBut/h 631.2	kBut/h 653.4	kBut/h 670.5	kBut/h 689.2
	Power input	kW 58.1	kW 59.3	kW 61.4	kW 63.9
	EER	kW/kW 3.18	kW/kW 3.23	kW/kW 3.20	kW/kW 3.16
Heating ²	Capacity	kW 185.0	kW 191.5	kW 196.5	kW 202.0
		kBut/h 631.2	kBut/h 653.4	kBut/h 670.5	kBut/h 689.2
	Power input	kW 47.3	kW 49.2	kW 50.5	kW 53.57
	COP	kW/kW 3.91	kW/kW 3.89	kW/kW 3.89	kW/kW 3.77
Connectable Indoor Unit	Total capacity	50-130% of outdoor unit capacity			
	Max. quantity	64			
Compressors	Type	DC inverter			
	Quantity	5			
Fan motors	Type	DC			
	Quantity	5			
Refrigerant	Max. ESP	Pa 20 Default; 60 Customize			
	Type	R410A			
Pipe connections ³	Factory charge	kg 11+17+25	kg 13+17+25	kg 13+17+25	kg 11+22+25
	Liquid pipe	mm Φ19.1	mm Φ19.1	mm Φ22.2	mm Φ22.2
	Gas pipe	mm Φ41.3	mm Φ41.3	mm Φ44.5	mm Φ44.5
Airflow rate	m ³ /h	54000		60000	
Sound pressure level ⁴	dB(A)	71			
Sound power level	dB(A)	93			
Net dimensions (WxHxD)	mm	(990×1635×790)+(1340×1635×825)+(1730×1830×850)	(1340×1635×850)+(1340×1635×825)+(1730×1830×850)	(990×1635×790)+(1730×1830×850)×2	(1730×1830×850)×2
Packed dimensions (WxHxD)	mm	(1090×1805×860)+(1405×1805×910)+(1800×2000×910)	(1405×1805×910)×2+(1800×2000×910)	(1090×1805×860)+(1800×2000×910)×2	(1800×2000×910)×2
Net weight	kg	227+348+475	277+348+475	227+430+475	227+430+475
Gross weight	kg	242+368+507	304+368+507	242+453+507	242+453+507
Ambient temp. operating range	Cooling	°C -5 to 48			
	Heating	°C -25 to 24			



Capacity	HP	74	76	78	80
Model		MV6-2075WV2GN1-E	MV6-2130WV2GN1-E	MV6-2185WV2GN1-E	MV6-2245WV2GN1-E
Combination type		20HP+22HP+32HP	22HP+22HP+32HP	22HP+24HP+32HP	22HP+26HP+32HP
Power supply	V/Ph/Hz	380-415/3/50			
Cooling ¹	Capacity	kW 207.5	kW 213.0	kW 218.5	kW 224.5
		kBut/h 708.0	kBut/h 726.8	kBut/h 745.5	kBut/h 766.0
	Power input	kW 64.5	kW 67.8	kW 67.5	kW 70.3
	EER	kW/kW 3.22	kW/kW 3.14	kW/kW 3.24	kW/kW 3.19
Heating ²	Capacity	kW 207.5	kW 213.0	kW 218.5	kW 224.5
		kBut/h 708.0	kBut/h 726.8	kBut/h 745.5	kBut/h 766.0
	Power input	kW 53.4	kW 55.7	kW 56.13	kW 58.91
	COP	kW/kW 3.88	kW/kW 3.82	kW/kW 3.89	kW/kW 3.81
Connectable Indoor Unit	Total capacity	50-130% of outdoor unit capacity			
	Max. quantity	64			
Compressors	Type	DC inverter			
	Quantity	6			
Fan motors	Type	DC			
	Quantity	6			
Refrigerant	Max. ESP	Pa 20 Default; 60 Customize			
	Type	R410A			
Pipe connections ³	Factory charge	kg 17×2+25	kg 17×2+25	kg 17×2+25	kg 17×2+25
	Liquid pipe	mm Φ22.2	mm Φ22.2	mm Φ22.2	mm Φ22.2
	Gas pipe	mm Φ44.5	mm Φ44.5	mm Φ44.5	mm Φ44.5
Airflow rate	m ³ /h	58000		66000	
Sound pressure level ⁴	dB(A)	72			
Sound power level	dB(A)	94			
Net dimensions (WxHxD)	mm	(1340×1635×825)×2+(1730×1830×850)		(1340×1635×825)+(1730×1830×850)×2	
Packed dimensions (WxHxD)	mm	(1405×1805×910)×2+(1800×2000×910)		(1405×1805×910)+(1800×2000×910)×2	
Net weight	kg	348+2+475		348+430+475	
Gross weight	kg	368×2+507		368+453+507	
Ambient temp. operating range	Cooling	°C -5 to 48			
	Heating	°C -25 to 24			

- Notes:
- Indoor temperature 27°C DB, 19°C WB; outdoor temperature 35°C DB; equivalent refrigerant piping length 7.5m with zero level difference.
 - Indoor temperature 20°C DB; outdoor temperature 7°C DB, 6°C WB; equivalent refrigerant piping length 7.5m with zero level difference.
 - Diameters given are those for the pipe connecting the outdoor unit combination to the first indoor branch joint for systems with total equivalent liquid piping lengths of less than 90m. For systems with total equivalent liquid piping lengths of 90m or longer, please refer to the V6 Series Engineering Data Book for connection piping diameters.
 - Sound pressure level is measured at a position 1m in front of the unit and 1.3m above the floor in a semi-anechoic chamber.

Specifications



Capacity	HP	82	84	86	88
Model		MV6-2300WV2GN1-E	MV6-2360WV2GN1-E	MV6-2415WV2GN1-E	MV6-2470WV2GN1-E
Combination type		22HP+28HP+32HP	26HP+26HP+32HP	26HP+28HP+32HP	28HP+28HP+32HP
Power supply	V/Ph/Hz	380-415/3/50			
Cooling ¹	Capacity	kW 230.0	kW 236.0	kW 241.5	kW 247.0
		kBut/h 784.8	kBut/h 805.2	kBut/h 824.0	kBut/h 842.8
	Power input	kW 73.5	kW 72.8	kW 76.1	kW 79.3
	EER	kW/kW 3.13	kW/kW 3.24	kW/kW 3.17	kW/kW 3.11
Heating ²	Capacity	kW 230.0	kW 236.0	kW 241.5	kW 247.0
		kBut/h 784.8	kBut/h 805.2	kBut/h 824.0	kBut/h 842.8
	Power input	kW 62.07	kW 61.92	kW 65.08	kW 68.24
	COP	kW/kW 3.71	kW/kW 3.81	kW/kW 3.71	kW/kW 3.62
Connectable Indoor Unit	Total capacity	50-130% of outdoor unit capacity			
	Max. quantity	64			
Compressors	Type	DC inverter			
	Quantity	6			
Fan motors	Type	DC			
	Quantity	6			
Refrigerant	Max. ESP	Pa 20 Default; 60 Customize			
	Type	R410A			
Pipe connections ³	Factory charge	kg 17+22+25	kg 17+22+25	kg 22×2+25	kg 22×2+25
	Liquid pipe	mm Φ22.2	mm Φ22.2	mm Φ25.4	mm Φ25.4
	Gas pipe	mm Φ44.5	mm Φ44.5	mm Φ50.8	mm Φ50.8
Airflow rate	m ³ /h	66000		74000	
Sound pressure level ⁴	dB(A)	72			
Sound power level	dB(A)	94			
Net dimensions (WxHxD)	mm	(1340×1635×825)+(1730×1830×850)×2		(1730×1830×850)×3	
Packed dimensions (WxHxD)	mm	(1405×1805×910)+(1800×2000×910)×2		(1800×2000×910)×3	
Net weight	kg	348+430+475		430×2+475	
Gross weight	kg	368+453+507		453×2+507	
Ambient temp. operating range	Cooling	°C -5 to 48			
	Heating	°C -25 to 24			



Capacity	HP	90	92	94	96
Model		MV6-2535WV2GN1-E	MV6-2585WV2GN1-E	MV6-2650WV2GN1-E	MV6-2700WV2GN1-E
Combination type		28HP+30HP+32HP	28HP+32HP+32HP	30HP+32HP+32HP	32HP+32HP+32HP
Power supply	V/Ph/Hz	380-415/3/50			
Cooling ¹	Capacity	kW 253.5	kW 258.5	kW 265.0	kW 270.0
		kBut/h 864.9	kBut/h 882.0	kBut/h 904.2	kBut/h 921.2
	Power input	kW 82.6	kW 86.2	kW 89.5	kW 93.1
	EER	kW/kW 3.07	kW/kW 3.00	kW/kW 2.96	kW/kW 2.90
Heating ²	Capacity	kW 253.5	kW 258.5	kW 265.0	kW 270.0
		kBut/h 864.9	kBut/h 882.0	kBut/h 904.2	kBut/h 921.2
	Power input	kW 69.97	kW 72.67	kW 74.4	kW 77.1
	COP	kW/kW 3.62	kW/kW 3.56	kW/kW 3.56	kW/kW 3.50
Connectable Indoor Unit	Total capacity	50-130% of outdoor unit capacity			
	Max. quantity	64			
Compressors	Type	DC inverter			
	Quantity	6			
Fan motors	Type	DC			
	Quantity	6			
Refrigerant	Max. ESP	Pa 20 Default; 60 Customize			
	Type	R410A			
Pipe connections ³	Factory charge	kg 22+25×2	kg 22+25×2	kg 25+25×2	kg 25+25×2
	Liquid pipe	mm Φ25.4	mm Φ25.4	mm Φ25.4	mm Φ25.4
	Gas pipe	mm Φ50.8	mm Φ50.8	mm Φ50.8	mm Φ50.8
Airflow rate	m ³ /h	73000		72000	
Sound pressure level ⁴	dB(A)	72			
Sound power level	dB(A)	94			
Net dimensions (WxHxD)	mm	(1730×1830×850)×3			
Packed dimensions (WxHxD)	mm	(1800×2000×910)×3			
Net weight	kg	430+475×2		475×3	
Gross weight	kg	453+507×2		507×3	
Ambient temp. operating range	Cooling	°C -5 to 48			
	Heating	°C -25 to 24			

- Notes:
- Indoor temperature 27°C DB, 19°C WB; outdoor temperature 35°C DB; equivalent refrigerant piping length 7.5m with zero level difference.
 - Indoor temperature 20°C DB; outdoor temperature 7°C DB, 6°C WB; equivalent refrigerant piping length 7.5m with zero level difference.
 - Diameters given are those for the pipe connecting the outdoor unit combination to the first indoor branch joint for systems with total equivalent liquid piping lengths of less than 90m. For systems with total equivalent liquid piping lengths of 90m or longer, please refer to the V6 Series Engineering Data Book for connection piping diameters.
 - Sound pressure level is measured at a position 1m in front of the unit and 1.3m above the floor in a semi-anechoic chamber.

2nd Generation VRF DC INDOOR UNITS



31

One-way Cassette

32

Two-way Cassette

33

Compact Four-way
Cassette

34

Four-way Cassette

35

Medium Static
Pressure Duct

36

High Static
Pressure Duct

37

Fresh Air
Processing Unit

38

Wall Mounted Unit

39

Ceiling / Floor Unit

40

Floor Standing Unit

42

Console



Wide Application Range

Wide Range of Indoor Units

With 11 types and more than 100 models, Midea VRF indoor units meet varied customer requirements in a wide range of locations including shopping malls, hospitals, office buildings, hotels and airports.

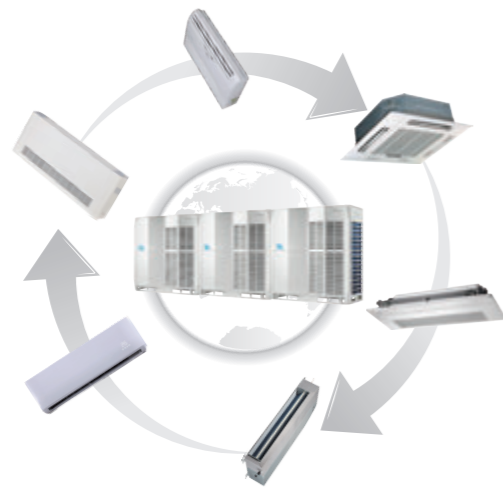

Multiple Appearance Options

For Wall Mounted Units, three interchangeable panels add extra flexibility to a universal body design.



For Four-way Cassette and Compact Four-way Cassette Units, interchangeable 360° airflow and four-way airflow panels are available.

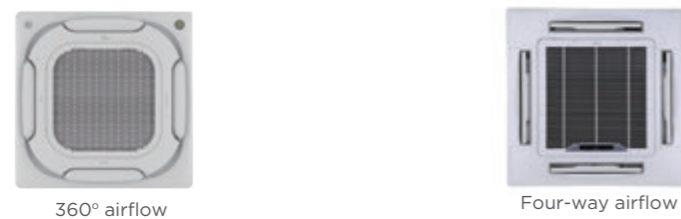

For Floor Standing Units, the F3B (concealed) unit is designed to be concealed in walls while the F4 (front air intake) and F5 (underside air intake) offer a choice of air intake options.



Comfort and Efficiency

High Efficiency DC Fan Motor

The power consumption of DC fan motor can be reduced greatly in comparison to corresponding AC type.



Quiet Operation

The low sound operation DC fan motor and optimized fan blades guarantees the air discharge smoothly and provides a quiet living environment.



Constant Level of Indoor Air Temperature

The DC Inverter fan motor adjusts of air flow based on thermal load instantly providing less temperature fluctuation and an improved living environment.

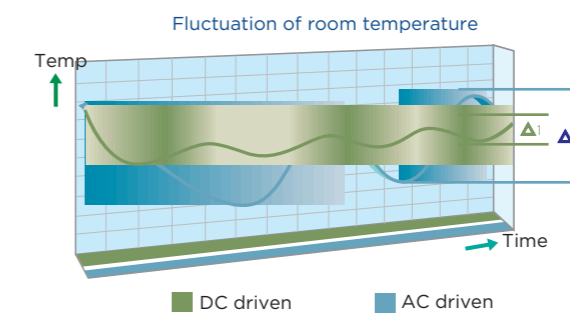

5-step Swing Louver

The air is comfortably spread upwards and downwards thanks to the 5-step swing louver that can be programmed via the controller.

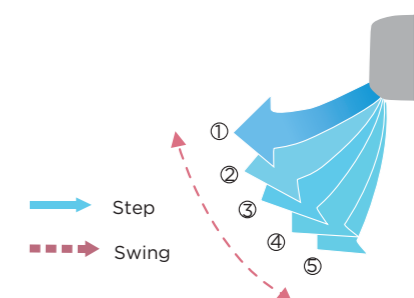

Comfort and Efficiency

Static Pressure 20 Steps Control (Duct Unit)

Depending on the installation environment, medium static pressure duct is controlled the static pressure up to 10 steps and high static pressure duct is controlled the static pressure up to 20 steps via wired remote controller, for providing comfortable environment suitable for any environment.

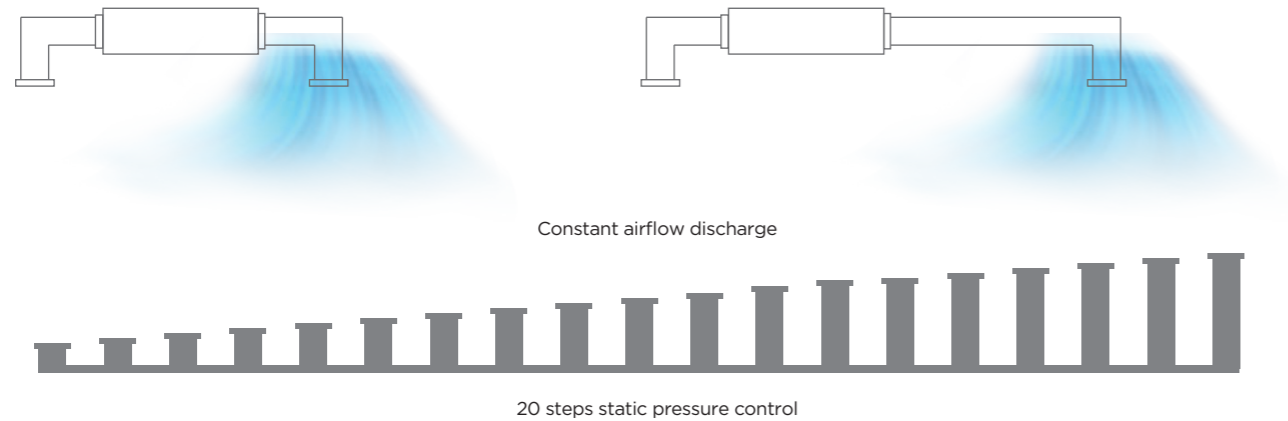

7-Speed Fan Control

7 indoor fan speeds provide control flexibility to meet the needs of different indoor conditions.

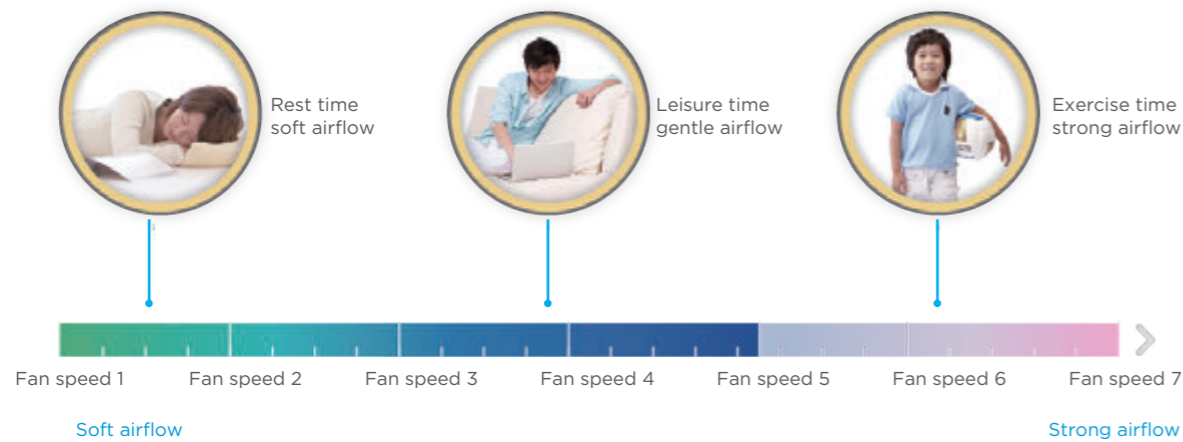

Fresh Air Intake

On selected models, a reserved outside air intake port allows outdoor air to be introduced directly into the unit, negating the need for a separate ventilation system.



Convenience

High-lift Drain Pump

A drain pump with a 750mm or 500mm pump head is fitted as standard or optional, simplifying installation of the drain piping.

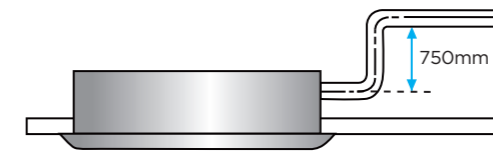

Flexible Installation

For Medium Static Pressure Duct Units, to provide the flexibility to adapt to differing installation situations, the air inlet may be positioned either on the underside or the rear of the unit.

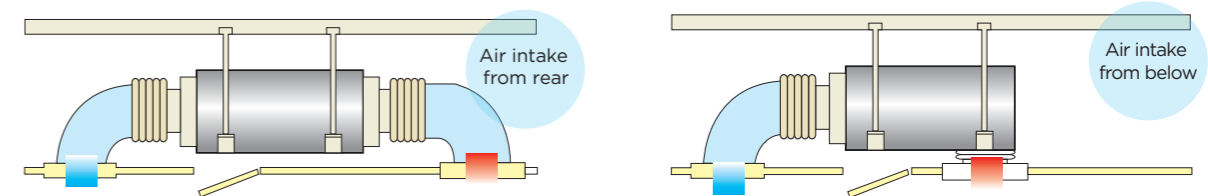

For Wall Mounted Units, the refrigerant outlet direction can be left, right or rear as the installation situation requires. A new fixing plate design speeds installation and provides extra stability.

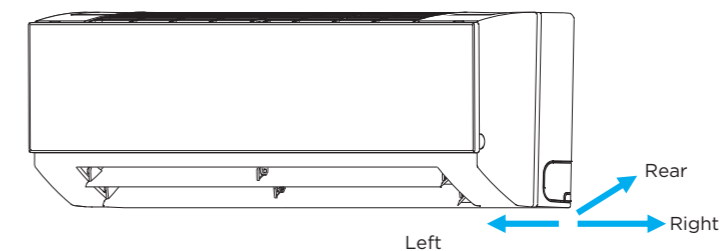

Ceiling / Floor Units can be installed either on the ceiling or the floor, providing flexibility to accommodate a wide range of room designs.

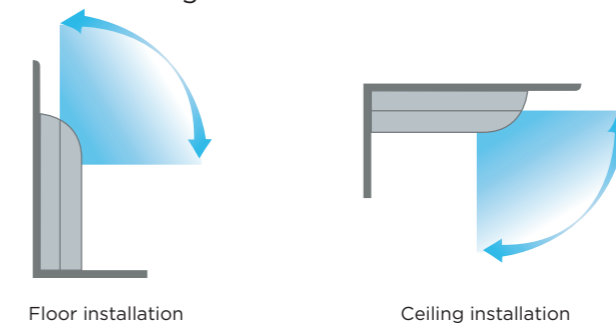

One-way Cassette

- Fresh air intake (45-71 models)
- One-way air discharge, ideal for corner locations
- Drain pump with 750mm pump head fitted as standard

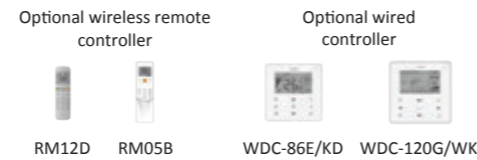

Model	MI2-18Q1DN1	MI2-22Q1DN1	MI2-28Q1DN1	MI2-36Q1DN1		
Power supply	1-phase, 220-240V, 50Hz					
Cooling ¹	Capacity	kW	1.8	2.2	2.8	3.6
		kBtu/h	6.1	7.5	9.6	12.3
	Power input	W	25	25	30	30
Heating ²	Capacity	kW	2.2	2.6	3.2	4.0
		kBtu/h	7.5	8.9	10.9	13.6
	Power input	W	25	25	30	30
Air flow rate ³	m ³ /h	523/482/448/404/360/312/275		573/531/492/456/420/364/315		
Sound pressure level ⁴	dB(A)	37/36/35/34/32/31/30		39/38/37/36/35/35/34		
Sound power level	dB(A)	51/50/49/48/46/45/44		53/52/51/50/49/49/48		
Main body	Net dimensions ⁵ (WxHxD)	mm 1054×153×425				
	Packed dimensions (WxHxD)	mm 1155×245×490				
	Net/Gross weight	kg 11.8/15.3		12.3/15.8		
Panel	Net dimensions (WxHxD)	mm 1180×25×465				
	Packed dimensions (WxHxD)	mm 1232×107×517				
	Net/Gross weight	kg 3.5/5.2				
Pipe connections	Liquid/Gas pipe	mm Φ6.35/Φ12.7				
	Drain pipe	mm OD Φ32				

Model	MI2-45Q1DN1	MI2-56Q1DN1	MI2-71Q1DN1		
Power supply	1-phase, 220-240V, 50Hz				
Cooling ¹	Capacity	kW	4.5	5.6	7.1
		kBtu/h	15.4	19.1	24.2
	Power input	W	40	48	60
Heating ²	Capacity	kW	5.0	6.3	8.0
		kBtu/h	17.1	21.5	27.3
	Power input	W	40	48	60
Air flow rate ³	m ³ /h	693/662/638/600/556/510/476	792/763/728/688/643/589/549	933/873/815/749/689/637/592	
Sound pressure level ⁴	dB(A)	41/40/39/38/37/36/35	42/41/40/39/38/37/36	44/43/42/41/39/38/37	
Sound power level	dB(A)	55/54/53/52/51/50/49	56/55/54/53/52/51/50	58/57/56/55/53/52/51	
Main body	Net dimensions ⁵ (WxHxD)	mm 1275×189×450			
	Packed dimensions (WxHxD)	mm 1370×295×505			
	Net/Gross weight	kg 16.1/20.4		17.6/22.4	
Panel	Net dimensions (WxHxD)	mm 1350×25×505			
	Packed dimensions (WxHxD)	mm 1410×95×560			
	Net/Gross weight	kg 4/5.4			
Pipe connections	Liquid/Gas pipe	mm Φ6.35/Φ12.7		Φ9.53/Φ15.9	
	Drain pipe	mm OD Φ32			

- Notes:
1. Indoor temperature 27°C DB, 19°C WB; outdoor temperature 35°C DB; equivalent refrigerant piping length 7.5m with zero level difference.
 2. Indoor temperature 20°C DB; outdoor temperature 7°C DB, 6°C WB; equivalent refrigerant piping length 7.5m with zero level difference.
 3. Each model's 7 airflow rate options are listed in order, from highest to lowest.
 4. Each model's 7 sound pressure levels are listed in order from highest to lowest and correspond to the model's 7 airflow rate options (see Note 3). Sound pressure level is measured 1.4m below the unit in a semi-anechoic chamber.
 5. Unit body dimensions given are the largest external dimensions of the unit, including hanger attachments.

Two-way Cassette

- Fresh air intake
- Two-way air discharge, perfect for limited ceiling space applications
- Drain pump with 750mm pump head fitted as standard

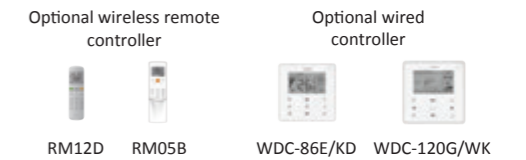

Model	MI2-22Q2DN1	MI2-28Q2DN1	MI2-36Q2DN1		
Power supply	1-phase, 220-240V, 50Hz				
Cooling ¹	Capacity	kW	2.2	2.8	3.6
		kBtu/h	7.5	9.6	12.3
	Power input	W	35	40	40
Heating ²	Capacity	kW	2.6	3.2	4.0
		kBtu/h	8.9	10.9	13.6
	Power input	W	35	40	40
Air flow rate ³	m ³ /h	654/612/571/530/488/449/410		725/679/641/591/554/509/458	
Sound pressure level ⁴	dB(A)	33/31/30/29/27/25/24		35/33/32/30/29/27/25	
Sound power level	dB(A)	49/47/46/45/43/41/40		51/49/48/46/45/43/41	
Main body	Net dimensions ⁵ (WxHxD)	mm 1172×299×591			
	Packed dimensions (WxHxD)	mm 1355×400×675			
	Net/Gross weight	kg 33.5/42.0			
Panel	Net dimensions (WxHxD)	mm 1430×53×680			
	Packed dimensions (WxHxD)	mm 1525×130×765			
	Net/Gross weight	kg 10.5/15			
Pipe connections	Liquid/Gas pipe	mm Φ6.35/Φ12.7			
	Drain pipe	mm OD Φ32			

Model	MI2-45Q2DN1	MI2-56Q2DN1	MI2-71Q2DN1		
Power supply	1-phase, 220-240V, 50Hz				
Cooling ¹	Capacity	kW	4.5	5.6	7.1
		kBtu/h	15.4	19.1	24.2
	Power input	W	50	69	98
Heating ²	Capacity	kW	5.0	6.3	8.0
		kBtu/h	17.1	21.5	27.3
	Power input	W	50	69	98
Air flow rate ³	m ³ /h	850/792/731/670/631/592/550	980/925/855/800/755/702/670	1200/1115/1068/1000/921/808/770	
Sound pressure level ⁴	dB(A)	37/36/35/34/32/31/30	39/37/36/35/33/31/30	44/42/41/40/38/36/34	
Sound power level	dB(A)	53/52/51/50/48/47/46	55/53/52/51/49/47/46	60/58/57/56/54/52/50	
Main body	Net dimensions ⁵ (WxHxD)	mm 1172×299×591			
	Packed dimensions (WxHxD)	mm 1355×400×675			
	Net/Gross weight	kg 35/43.5			
Panel	Net dimensions (WxHxD)	mm 1430×53×680			
	Packed dimensions (WxHxD)	mm 1525×130×765			
	Net/Gross weight	kg 10.5/15			
Pipe connections	Liquid/Gas pipe	mm Φ6.35/Φ12.7		Φ9.53/Φ15.9	
	Drain pipe	mm OD Φ32			

- Notes:
1. Indoor temperature 27°C DB, 19°C WB; outdoor temperature 35°C DB; equivalent refrigerant piping length 7.5m with zero level difference.
 2. Indoor temperature 20°C DB; outdoor temperature 7°C DB, 6°C WB; equivalent refrigerant piping length 7.5m with zero level difference.
 3. Each model's 7 airflow rate options are listed in order, from highest to lowest.
 4. Each model's 7 sound pressure levels are listed in order from highest to lowest and correspond to the model's 7 airflow rate options (see Note 3). Sound pressure level is measured 1.4m below the unit in a semi-anechoic chamber.
 5. Unit body dimensions given are the largest external dimensions of the unit, including hanger attachments.

Compact Four-way Cassette

- 360° airflow allows for even, wide-range cooling and heating
- Drain pump with 500mm pump head fitted as standard

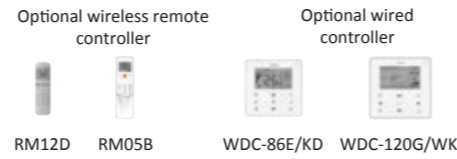

Model	MI2-22Q4CDN1	MI2-28Q4CDN1	MI2-36Q4CDN1	MI2-45Q4CDN1		
Power supply	1-phase, 220-240V, 50Hz					
Cooling ¹	Capacity	kW	2.2	2.8	3.6	4.5
		kBtu/h	7.5	9.6	12.3	15.4
	Power input	W	35	35	40	50
Heating ²	Capacity	kW	2.4	3.2	4.0	5.0
		kBtu/h	8.2	10.9	13.6	17.1
	Power input	W	35	35	40	50
Air flow rate ³	m ³ /h	576/552/524/503/462/441/405		604/573/541/516/478/434/400		
Sound pressure level ⁴	dB(A)	35/34/33/29/26/23/22		41/38/35/32/30/29/28		
Sound power level	dB(A)	51/50/49/45/42/39/38		56/53/50/47/45/44/43		
Main body	Net dimensions ⁵ (WxHxD)	mm	630×260×570			
	Packed dimensions (WxHxD)	mm	700×345×660			
	Net/Gross weight	kg	18/23.5	19.2/24.7		
Panel	Net dimensions (WxHxD)	mm	647×50×647			
	Packed dimensions (WxHxD)	mm	715×123×715			
	Net/Gross weight	kg	2.5/4.5			
Pipe connections	Liquid/Gas pipe	mm	Φ6.35/Φ12.7			
	Drain pipe	mm	OD Φ32			

Notes:

1. Indoor temperature 27°C DB, 19°C WB; outdoor temperature 35°C DB; equivalent refrigerant piping length 7.5m with zero level difference.
2. Indoor temperature 20°C DB; outdoor temperature 7°C DB, 6°C WB; equivalent refrigerant piping length 7.5m with zero level difference.
3. Each model's 7 airflow rate options are listed in order, from highest to lowest.
4. Each model's 7 sound pressure levels are listed in order from highest to lowest and correspond to the model's 7 airflow rate options (see Note 3). Sound pressure level is measured 1.4m below the unit in a semi-anechoic chamber.
5. Unit body dimensions given are the largest external dimensions of the unit, including hanger attachments.

Four-way Cassette

- Fresh air intake
- Four-way airflow, allows wide-angle, equal distribution of cooling and heating
- Drain pump with 750mm pump head fitted as standard
- Brand-new, elegant panel with four independently controlled louvers

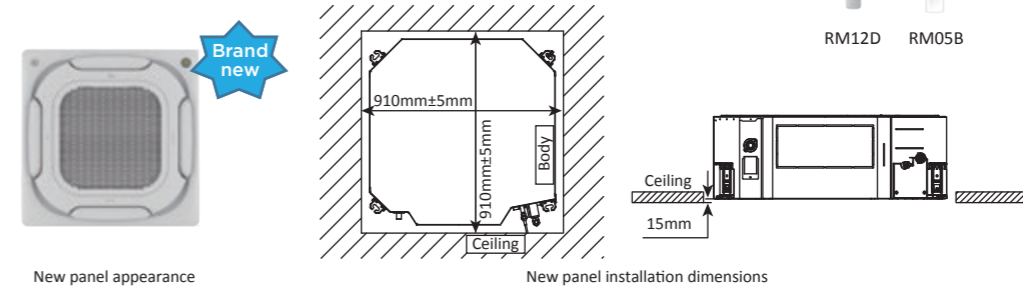
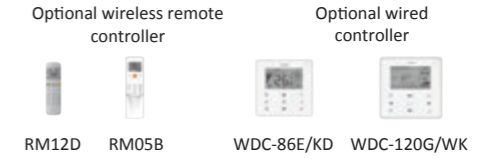

Model	MI2-28Q4DN1	MI2-36Q4DN1	MI2-45Q4DN1	MI2-56Q4DN1	MI2-71Q4DN1		
Power supply	1 phase, 220-240V, 50Hz						
Cooling ¹	Capacity	kW	2.8	3.6	4.5	5.6	7.1
		kBtu/h	9.6	12.3	15.4	19.1	24.2
	Power input	W	40	45	50	60	70
Heating ²	Capacity	kW	3.2	4.0	5.0	6.3	8.0
		kBtu/h	10.9	13.6	17.1	21.5	27.3
	Power input	W	40	45	50	60	70
Air flow rate ³	m ³ /h	801/751/711/658/637/611/542		893/866/804/744/714/698/635		977/937/864/800/778/738/671	
Sound pressure level ⁴	dB(A)	32/31/30/28/26/23		35/34/31/31/30/28/26		35/35/34/31/30/28/27	
Sound power level	dB(A)	47/46/45/43/41/39		50/49/46/46/45/42/40		50/49/47/47/45/42/41	
Main body	Net dimensions ⁵ (WxHxD)	mm	840×230×840				
	Packed dimensions (WxHxD)	mm	955×260×955				
	Net/Gross weight	kg	21.3/25.8	23.2/27.6			
Panel	Net dimensions (WxHxD)	mm	950×54.5×950				
	Packed dimensions (WxHxD)	mm	1035×90×1035				
	Net/Gross weight	kg	5/8				
Pipe connections	Liquid/Gas pipe	mm	Φ6.35/Φ12.7		Φ9.53/Φ15.9		
	Drain pipe	mm	OD Φ32				

Model	MI2-80Q4DN1	MI2-90Q4DN1	MI2-100Q4DN1	MI2-112Q4DN1	MI2-140Q4DN1		
Power supply	1 phase, 220-240V, 50Hz						
Cooling ¹	Capacity	kW	8.0	9.0	10.0	11.2	14.0
		kBtu/h	27.3	30.7	34.1	38.2	47.8
	Power input	W	96	100	150	160	170
Heating ²	Capacity	kW	9.0	10.0	11.0	12.5	16.0
		kBtu/h	30.7	34.1	37.5	42.7	54.6
	Power input	W	96	100	150	160	170
Air flow rate ³	m ³ /h	1203/1131/1064/977/912/840/774	1349/1294/1230/1201/1111/1029/970	1641/1544/1431/1309/1225/1198/1143		1662/1574/1448/1348/1253/1219/1170	
Sound pressure level ⁴	dB(A)	36/35/34/31/31/29/28	37/35/34/31/31/30/28	38/36/35/34/31/31/30		39/37/36/35/34/31/31	
Sound power level	dB(A)	52/49/48/46/46/42/42	53/49/48/46/46/44/43	55/52/49/48/46/46/44		56/55/52/49/48/46/46	
Main body	Net dimensions ⁵ (WxHxD)	mm	840×300×840				
	Packed dimensions (WxHxD)	mm	955×260×955				
	Net/Gross weight	kg	23.2/27.6	28.4/33.8		30.7/35.8	
Panel	Net dimensions (WxHxD)	mm	950×54.5×950				
	Packed dimensions (WxHxD)	mm	1035×90×1035				
	Net/Gross weight	kg	5/8				
Pipe connections	Liquid/Gas pipe	mm	Φ9.53/Φ15.9				
	Drain pipe	mm	OD Φ32				

Notes:

1. Indoor temperature 27°C DB, 19°C WB; outdoor temperature 35°C DB; equivalent refrigerant piping length 7.5m with zero level difference.
2. Indoor temperature 20°C DB; outdoor temperature 7°C DB, 6°C WB; equivalent refrigerant piping length 7.5m with zero level difference.
3. Each model's 7 airflow rate options are listed in order, from highest to lowest.
4. Each model's 7 sound pressure levels are listed in order from highest to lowest and correspond to the model's 7 airflow rate options (see Note 3). Sound pressure level is measured 1.4m below the unit in a semi-anechoic chamber.
5. Unit body dimensions given are the largest external dimensions of the unit, including hanger attachments.

Medium Static Pressure Duct

- Fresh air intake
- 6-step static pressure control on 2.2kW to 7.1kW models and 10-step static pressure control on 8kW to 14kW units (requires latest generation wired controllers)
- Drain pump with 750mm pump head fitted as standard
- Flexible installation for the air inlet may be positioned either on the underside or the rear of the unit

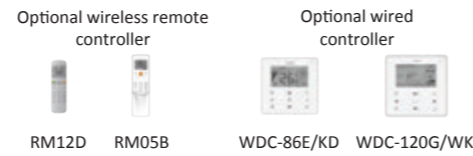
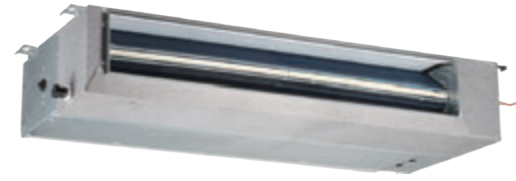

Model		MI2-22T2DN1	MI2-28T2DN1	MI2-36T2DN1	
Power supply		1 phase, 220-240V, 50Hz			
Cooling ¹	Capacity	kW	2.2	2.8	3.6
		kBtu/h	7.5	9.6	12.3
	Power input	W	40	45	45
Heating ²	Capacity	kW	2.6	3.2	4.0
		kBtu/h	8.2	10.9	13.6
	Power input	W	40	45	45
Air flow rate ³	m ³ /h	520/480/440/400/360/330/300		580/540/500/460/430/400/370	
External static pressure	Pa	10 (0~50)			
Sound pressure level ⁴	dB(A)	32/31/29/28/26/25/23		33/32/31/30/28/27/25	
Sound power level	dB(A)	50/49/47/46/44/43/41		51/50/49/48/46/45/43	
Unit	Net dimensions ⁵ (WxHxD)	mm	780×210×500		
	Packed dimensions (WxHxD)	mm	870×285×525		
	Net/Gross weight	kg	18/21		
	Liquid/Gas pipe	mm	Φ6.35/Φ12.7		
Drain pipe	mm	OD Φ25			

Model		MI2-45T2DN1	MI2-56T2DN1	MI2-71T2DN1	
Power supply		1 phase, 220-240V, 50Hz			
Cooling ¹	Capacity	kW	4.5	5.6	7.1
		kBtu/h	15.4	19.1	24.2
	Power input	W	92	98	98
Heating ²	Capacity	kW	5.0	6.3	8.0
		kBtu/h	17.1	21.5	27.3
	Power input	W	92	98	98
Air flow rate ³	m ³ /h	800/740/680/620/540/480/400	830/760/720/680/640/600/560	1000/960/900/840/780/720/680	
External static pressure	Pa	10 (0~50)			
Sound pressure level ⁴	dB(A)	36/34/32/31/29/27/25	36/34/33/32/30/29/28	37/35/33/32/30/29/28	
Sound power level	dB(A)	54/52/50/49/47/45/43	54/52/51/50/48/47/46	55/53/51/50/48/47/46	
Unit	Net dimensions ⁵ (WxHxD)	mm	1000×210×500		
	Packed dimensions (WxHxD)	mm	1115×285×525		
	Net/Gross weight	kg	21.5/25		
	Liquid/Gas pipe	mm	Φ6.35/Φ12.7	Φ9.53/Φ15.9	Φ9.53/Φ15.9
Drain pipe	mm	OD Φ25			

Model		MI2-80T2DN1	MI2-90T2DN1	MI2-112T2DN1	MI2-140T2DN1	
Power supply		1 phase, 220-240V, 50Hz				
Cooling ¹	Capacity	kW	8.0	9.0	11.2	14.0
		kBtu/h	27.3	30.7	38.2	47.8
	Power input	W	110	120	200	250
Heating ²	Capacity	kW	9.0	10.0	12.5	15.5
		kBtu/h	30.7	34.1	42.7	52.9
	Power input	W	110	120	200	250
Air flow rate ³	m ³ /h	1260/1180/1100/1020/940/860/780	1500/1430/1360/1290/1210/1140/1080	1960/1860/1760/1660/1560/1460/1360		
External static pressure	Pa	20 (10~100)		40 (30~150)		
Sound pressure level ⁴	dB(A)	37/35/34/33/31/29/28		39/38/38/37/35/34/33		
Sound power level	dB(A)	55/53/52/51/49/47/46		57/56/56/55/53/52/51		
Unit	Net dimensions ⁵ (WxHxD)	mm			1230×270×775	1290×300×865
	Packed dimensions (WxHxD)	mm			1355×355×795	1400×375×925
	Net/Gross weight	kg		36.5/44.5	37/45	46.5/55.5
	Liquid/Gas pipe	mm				Φ9.53/Φ15.9
Drain pipe	mm					OD Φ25

- Notes:
1. Indoor temperature 27°C DB, 19°C WB; outdoor temperature 35°C DB; equivalent refrigerant piping length 7.5m with zero level difference.
 2. Indoor temperature 20°C DB; outdoor temperature 7°C DB, 6°C WB; equivalent refrigerant piping length 7.5m with zero level difference.
 3. Each model's 7 airflow rate options are listed in order, from highest to lowest.
 4. Each model's 7 sound pressure levels are listed in order from highest to lowest and correspond to the model's 7 airflow rate options (see Note 3). Sound pressure level is measured 1.4m below the unit in a semi-anechoic chamber.
 5. Unit body dimensions given are the largest external dimensions of the unit, including hanger attachments.
- All specifications are measured at standard external static pressure.

High Static Pressure Duct

- External static pressure up to 400Pa facilitates extensive duct and grille network
- 20-step static pressure control on all models (requires latest generation wired controllers)
- A double-skin drainage pan provides double protection for ceilings (models 71 to 160).
- Drain pump with a 750mm pump head available as a customization option

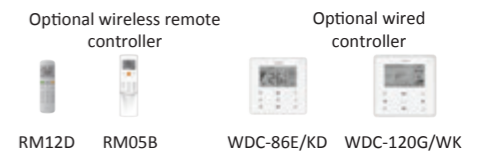

Model		MI2-71T1DN1	MI2-80T1DN1	MI2-90T1DN1		
Power supply		1 phase, 220-240V, 50Hz				
Cooling ¹	Capacity	kW	7.1	8.0	9.0	
		kBtu/h	24.2	27.3	30.7	
	Power input	W	180	180	220	
Heating ²	Capacity	kW	8.0	9.0	10.0	
		kBtu/h	27.3	30.7	34.1	
	Power input	W	180	180	220	
Air flow rate ³	m ³ /h	1360/1327/1293/1260/1227/1193/1160	1360/1327/1293/1260/1227/1193/1160	1420/1373/1327/1280/1233/1187/1140		
External static pressure	Pa	100 (30~200)				
Sound pressure level ⁴	dB(A)	46/46/45/45/44/43/42	46/46/45/45/44/43/42	50/49/48/48/47/46/45		
Sound power level	dB(A)	64/64/63/63/62/61/60	64/64/63/63/62/61/60	68/67/66/66/65/64/63		
Unit	Net dimensions ⁵ (WxHxD)	mm			965×423×690	
	Packed dimensions (WxHxD)	mm			1090×440×768	
	Net/Gross weight	kg		41/47	51/57	
	Liquid/Gas pipe	mm				Φ9.53/Φ15.9
Drain pipe	mm					OD Φ25

Model		MI2-112T1DN1	MI2-140T1DN1	MI2-160T1DN1		
Power supply		1 phase, 220-240V, 50Hz				
Cooling ¹	Capacity	kW	11.2	14.0	16.0	
		kBtu/h	38.2	47.8	54.6	
	Power input	W	380	420	700	
Heating ²	Capacity	kW	12.5	16.0	17.0	
		kBtu/h	42.7	54.6	58.0	
	Power input	W	380	420	700	
Air flow rate ³	m ³ /h	1870/1783/1697/1610/1523/1437/1350	2240/2133/2027/1920/1813/1707/1600	2660/2530/2400/2270/2140/2010/1880		
External static pressure	Pa	100 (30~200)				
Sound pressure level ⁴	dB(A)	50/50/49/48/47/46/45	53/52/51/51/50/49/48	54/54/53/52/51/50/50		
Sound power level	dB(A)	68/68/67/66/65/64/63	71/70/69/69/68/67/66	72/72/71/70/69/68/68		
Unit	Net dimensions ⁵ (WxHxD)	mm		965×423×690	1322×423×691	
	Packed dimensions (WxHxD)	mm		1090×440×768	1436×450×768	
	Net/Gross weight	kg		51/57	68/76	
	Liquid/Gas pipe	mm				Φ9.53/Φ15.9
Drain pipe	mm					OD Φ25

Model		MI2-200T1DN1	MI2-250T1DN1	MI2-280T1DN1	MI2-560T1DN1	
Power supply		1 phase, 220-240V, 50Hz				
Cooling ¹	Capacity	kW	20.0	25.0	28.0	56.0
		kBtu/h	68.2	85.3	95.5	191.1
	Power input	W	990	1200	1200	2272
Heating ²	Capacity	kW	22.5	26.0	31.5	63.0
		kBtu/h	76.8	88.7	107.5	215.0
	Power input	W	990	1200	1200	2272
Air flow rate ³	m ³ /h	4330/4230/4130/4030/3930/3830/3730			7400/7000/6600/6200/5800/5400/5000	
External static pressure	Pa	170 (20~250)		300 (100~400)		
Sound pressure level ⁴	dB(A)	57/56/55/54/53/52/50		59/58/57/56/55/53/51		
Sound power level	dB(A)	75/74/73/72/71/70/68		77/76/75/74/73/71/69		
Unit	Net dimensions ⁵ (WxHxD)	mm			1454×515×931	2005×929×670
	Packed dimensions (WxHxD)	mm			1509×550×990	2095×964×800
	Net/Gross weight	kg		130/142	218/248	
	Liquid/Gas pipe	mm				Φ12.7/Φ22.2
Drain pipe	mm					OD Φ32

- Notes:
1. Indoor temperature 27°C DB, 19°C WB; outdoor temperature 35°C DB; equivalent refrigerant piping length 7.5m with zero level difference.
 2. Indoor temperature 20°C DB; outdoor temperature 7°C DB, 6°C WB; equivalent refrigerant piping length 7.5m with zero level difference.
 3. Each model's 7 airflow rate options are listed in order, from highest to lowest.
 4. Each model's 7 sound pressure levels are listed in order from highest to lowest and correspond to the model's 7 airflow rate options (see Note 3). Sound pressure level is measured 1.4m below the unit in a semi-anechoic chamber.
 5. Unit body dimensions given are the largest external dimensions of the unit, including hanger attachments.
- All specifications are measured at standard external static pressure.

Fresh Air Processing Unit

- 100% fresh air processing unit, both fresh air filtration and heating/cooling can be achieved in a single system
- External static pressure up to 400Pa facilitates extensive duct and grille network
- 20-step static pressure control on all models (requires latest generation wired controllers)
- Drain pump with a 750mm pump head available as a customization option

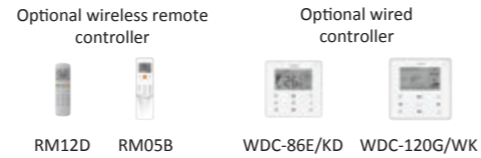
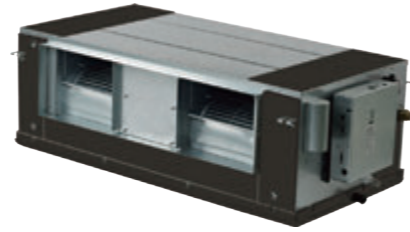

Model	MI2-125FADN1		MI2-140FADN1	
Power supply	1 phase, 220-240V, 50Hz			
Cooling ¹	Capacity	kW	12.5	14.0
		kBtu/h	42.6	47.8
Power input	W	480	480	
	Capacity	kW	10.5	12.0
Heating ²		kBtu/h	36.0	41.0
	Power input	W	480	480
Air flow rate ³	m ³ /h	2000/1917/1833/1750/1667/1583/1500		
External static pressure	Pa	180 (30~200)		
Sound pressure level ⁴	dB(A)	48/47/46/45/44/43/42		
Sound power level	dB(A)	66/65/64/63/62/61/60		
Unit	Net dimensions ⁵ (WxHxD)	mm	1322x423x691	
	Packed dimensions (WxHxD)	mm	1436x450x768	
	Net/Gross weight	kg	68/76	
Pipe connections	Liquid/Gas pipe	mm	Φ9.53/Φ15.9	
	Drain pipe	mm	OD Φ25	

Model	MI2-200FADN1	MI2-250FADN1	MI2-280FADN1	MI2-560FADN1		
Power supply	1 phase, 220-240V, 50Hz					
Cooling ¹	Capacity	kW	20.0	25.0	28.0	56.0
		kBtu/h	68.2	85.3	95.5	191.1
Power input	W	850	850	850	2272	
	Capacity	kW	12.8	16.0	18.0	39.0
Heating ²		kBtu/h	43.7	54.6	61.4	133.1
	Power input	W	850	850	850	2272
Air flow rate ³	m ³ /h	3000/2833/2667/2500/2333/2167/2000			7400/7000/6600/6200/5800/5400/5000	
External static pressure	Pa	200 (30~250)			300 (100~400)	
Sound pressure level ⁴	dB(A)	50/49/48/47/46/44/43			59/58/57/56/54/53/51	
Sound power level	dB(A)	68/67/66/65/64/62/61			77/76/75/74/72/71/69	
Unit	Net dimensions ⁵ (WxHxD)	mm	1454x515x931		2005x929x670	
	Packed dimensions (WxHxD)	mm	1509x550x990		2095x964x800	
	Net/Gross weight	kg	130/142		218/248	
Pipe connections	Liquid/Gas pipe	mm	Φ12.7/Φ22.2		Φ15.9/Φ28.6	
	Drain pipe	mm	OD Φ32			

Notes:

1. Outdoor temperature 33°C DB, 28°C WB; equivalent refrigerant piping length 7.5m with zero level difference.
2. Outdoor temperature 0°C DB, -2.9°C WB; equivalent refrigerant piping length 7.5m with zero level difference.
3. Each model's 7 airflow rate options are listed in order, from highest to lowest.
4. Each model's 7 sound pressure levels are listed in order from highest to lowest and correspond to the model's 7 airflow rate options (see Note 3).
Sound pressure level is measured 1.4m below the unit in a semi-anechoic chamber.
5. Unit body dimensions given are the largest external dimensions of the unit, including hanger attachments.

All specifications are measured at standard external static pressure.
The Fresh Air Processing Unit can be used either independently or in conjunction with other types of indoor unit. If used independently, the total capacity of the Fresh Air Processing Units must be between 50% and 100% of that of the outdoor units. If used in conjunction with other types of indoor unit, the total capacity of the indoor units and Fresh Air Processing Units must be between 50% and 100% of that of the outdoor units and the total capacity of the Fresh Air Processing Units must not exceed 30% of that of the outdoor units.

Wall Mounted Unit

- Three interchangeable panels allow units to blend easily with any interior decoration, perfect for rooms with no false ceilings or free floor space
- Refrigerant outlet direction can be left, right or rear as the installation situation requires

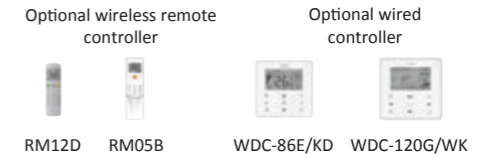

Model	MI2-22GDN1		MI2-28GDN1	
Power supply	1 phase, 220-240V, 50Hz			
Cooling ¹	Capacity	kW	2.2	2.8
		kBtu/h	7.5	9.6
Power input	W	28	28	
	Capacity	kW	2.4	3.2
Heating ²		kBtu/h	8.2	10.9
	Power input	W	28	28
Air flow rate ³	m ³ /h	422/411/402/393/380/368/356		417/402/386/370/353/338/316
Sound pressure level ⁴	dB(A)	31/30/30/30/29/29/29		31/30/30/30/29/29/29
Sound power level	dB(A)	46/45/45/45/44/44/44		46/45/45/45/44/44/44
Unit	Net dimensions ⁵ (WxHxD)	mm	835x280x203	
	Packed dimensions (WxHxD)	mm	935x385x320	
	Net/Gross weight	kg	8.4/12.1	
Pipe connections	Liquid/Gas pipe	mm	Φ6.35/Φ12.7	
	Drain pipe	mm	OD Φ16	

Model	MI2-36GDN1	MI2-45GDN1	MI2-56GDN1		
Power supply	1 phase, 220-240V, 50Hz				
Cooling ¹	Capacity	kW	3.6	4.5	5.6
		kBtu/h	12.3	15.4	19.1
Power input	W	30	40	45	
	Capacity	kW	4.0	5.0	6.3
Heating ²		kBtu/h	13.6	17.1	21.5
	Power input	W	30	40	45
Air flow rate ³	m ³ /h	656/628/591/573/544/515/488		594/563/535/507/478/450/424	747/713/685/648/613/578/547
Sound pressure level ⁴	dB(A)	33/32/32/31/31/30/30		35/34/33/33/32/31/31	38/37/36/36/35/34/34
Sound power level	dB(A)	48/47/47/46/46/45/45		50/49/48/48/47/46/46	53/52/51/51/50/49/49
Unit	Net dimensions ⁵ (WxHxD)	mm	990x315x223		
	Packed dimensions (WxHxD)	mm	1085x420x335		
	Net/Gross weight	kg	11.4/15.5		
Pipe connections	Liquid/Gas pipe	mm	Φ6.35/Φ12.7		
	Drain pipe	mm	OD Φ16		

Model	MI2-71GDN1	MI2-80GDN1	MI2-90GDN1		
Power supply	1 phase, 220-240V, 50Hz				
Cooling ¹	Capacity	kW	7.1	8.0	9.0
		kBtu/h	24.2	27.3	30.7
Power input	W	55	55	82	
	Capacity	kW	8.0	9.0	10.0
Heating ²		kBtu/h	27.3	30.7	34.1
	Power input	W	55	55	82
Air flow rate ³	m ³ /h	1195/1130/1065/1005/940/875/809		1195/1130/1065/1005/940/875/809	1421/1300/1125/1067/1005/934/867
Sound pressure level ⁴	dB(A)	44/43/42/39/38/37/36		44/43/42/39/38/37/36	48/46/45/43/41/40/38
Sound power level	dB(A)	59/58/57/54/53/52/51		59/58/57/54/53/52/51	63/61/60/58/56/55/53
Unit	Net dimensions ⁵ (WxHxD)	mm	1194x343x262		
	Packed dimensions (WxHxD)	mm	1290x375x460		
	Net/Gross weight	kg	17.0/22.4		
Pipe connections	Liquid/Gas pipe	mm	Φ9.53/Φ15.9		
	Drain pipe	mm	OD Φ16		

Notes:

1. Indoor temperature 27°C DB, 19°C WB; outdoor temperature 35°C DB; equivalent refrigerant piping length 7.5m with zero level difference.
2. Indoor temperature 20°C DB; outdoor temperature 7°C DB, 6°C WB; equivalent refrigerant piping length 7.5m with zero level difference.
3. Each model's 7 airflow rate options are listed in order, from highest to lowest.
4. Each model's 7 sound pressure levels are listed in order from highest to lowest and correspond to the model's 7 airflow rate options (see Note 3).
Sound pressure level is measured 1m in front and 1m below the unit in a semi-anechoic chamber.
5. Unit body dimensions given are the largest external dimensions of the unit, including hanger attachments.

Ceiling / Floor



- Can be installed either on the ceiling or floor



Model		MI2-36DLN1	MI2-45DLN1	MI2-56DLN1	MI2-71DLN1	
Power supply		1 phase, 220-240V, 50Hz				
Cooling ¹	Capacity	kW	3.6	4.5	5.6	7.1
		kBtu/h	12.3	15.4	19.1	24.2
	Power input	W	49	115	115	115
Heating ²	Capacity	kW	4.0	5.0	6.3	8.0
		kBtu/h	13.6	17.1	21.5	27.3
	Power input	W	49	115	115	115
Air flow rate ³	m ³ /h	550/525/500/480/460/440/420		930/895/860/830/792/755/720		
Sound pressure level ⁴	dB(A)	40/39/38/38/37/36/36		43/42/41/41/39/38/38		
Sound power level	dB(A)	53/52/51/51/50/49/49		56/55/54/54/52/51/51		
Unit	Net dimensions ⁵ (WxHxD)	mm 990×660×203				
	Packed dimensions (WxHxD)	mm 1089×744×296				
	Net/Gross weight	kg	27/33	28/34		
Pipe connections	Liquid/Gas pipe	mm Φ6.35/Φ12.7		Φ9.53/Φ15.9		
	Drain pipe	mm OD Φ16				

Model		MI2-80DLN1	MI2-90DLN1	MI2-112DLN1	MI2-140DLN1	
Power supply		1 phase, 220-240V, 50Hz				
Cooling ¹	Capacity	kW	8.0	9.0	11.2	14.0
		kBtu/h	27.2	30.7	38.2	47.8
	Power input	W	130	130	180	180
Heating ²	Capacity	kW	9.0	10.0	12.5	15.0
		kBtu/h	30.7	34.1	42.7	51.2
	Power input	W	130	130	180	180
Air flow rate ³	m ³ /h	1280/1245/1210/1170/1130/1085/1050		1890/1830/1765/1700/1660/1620/1580		
Sound pressure level ⁴	dB(A)	45/44/43/43/42/41/40		47/46/45/45/44/43/42		
Sound power level	dB(A)	58/57/56/56/55/54/53		60/59/58/58/57/56/55		
Unit	Net dimensions ⁵ (WxHxD)	mm 1280×660×203		1670×680×244		
	Packed dimensions (WxHxD)	mm 1379×744×296		1915×760×330		
	Net/Gross weight	kg	35/41		48/58	
Pipe connections	Liquid/Gas pipe	mm Φ9.53/Φ15.9				
	Drain pipe	mm OD Φ16				

Notes:

1. Indoor temperature 27°C DB, 19°C WB; outdoor temperature 35°C DB; equivalent refrigerant piping length 7.5m with zero level difference.
2. Indoor temperature 20°C DB; outdoor temperature 7°C DB, 6°C WB; equivalent refrigerant piping length 7.5m with zero level difference.
3. Each model's 7 airflow rate options are listed in order, from highest to lowest.
4. Each model's 7 sound pressure levels are listed in order from highest to lowest and correspond to the model's 7 airflow rate options (see Note 3).
Floor standing: Sound pressure level is measured 1m in front and 1m above the floor in a semi-anechoic chamber.
Ceiling mounted: Sound pressure level is measured 1m in front and 1m below the unit in a semi-anechoic chamber.
5. Unit body dimensions given are the largest external dimensions of the unit, including hanger attachments.

Floor Standing Unit (Concealed)

- Designed to be concealed in walls with only the suction and discharge grills visible



Model		MI2-22F3DN1	MI2-28F3DN1
Power supply		1 phase, 220-240V, 50Hz	
Cooling ¹	Capacity	kW 2.2	2.8
	Power input	kBtu/h 7.5	9.6
Heating ²	Capacity	W 40	45
		kW 2.4	3.2
	Power input	kBtu/h 8.2	10.9
Air flow rate ³	W 40	45	
Air flow rate ³	m ³ /h	530/504/478/456/439/418/400	
Sound pressure level ⁴	dB(A)	36/35/34/33/31/30/29	
Sound power level	dB(A)	54/53/52/51/49/48/47	
Unit	Net dimensions ⁵ (WxHxD)	mm 840×545×212	
	Packed dimensions (WxHxD)	mm 939×639×305	
	Net/Gross weight	kg 21/25.5	
Pipe connections	Liquid/Gas pipe	mm Φ6.35/Φ12.7	
	Drain pipe	mm Φ16	

Model		MI2-36F3DN1	MI2-45F3DN1
Power supply		1 phase, 220-240V, 50Hz	
Cooling ¹	Capacity	kW 3.6	4.5
	Power input	kBtu/h 12.3	15.4
Heating ²	Capacity	W 55	60
		kW 4.0	5.0
	Power input	kBtu/h 13.6	17.1
Air flow rate ³	W 55	60	
Air flow rate ³	m ³ /h	624/591/557/522/473/420/375	
Sound pressure level ⁴	dB(A)	37/36/35/34/32/31/30	
Sound power level	dB(A)	55/54/53/52/51/49/48	
Unit	Net dimensions ⁵ (WxHxD)	mm 1040×545×212	
	Packed dimensions (WxHxD)	mm 1139×639×305	
	Net/Gross weight	kg 25.5/30.5	
Pipe connections	Liquid/Gas pipe	mm Φ6.35/Φ12.7	
	Drain pipe	mm Φ16	

Model		MI2-56F3DN1	MI2-71F3DN1	MI2-80F3DN1
Power supply		1 phase, 220-240V, 50Hz		
Cooling ¹	Capacity	kW 5.6	7.1	8.0
	Power input	kBtu/h 19.1	24.2	27.3
Heating ²	Capacity	W 88	110	130
		kW 6.3	8.0	9.0
	Power input	kBtu/h 21.5	27.3	30.7
Air flow rate ³	W 88	110	130	
Air flow rate ³	m ³ /h	1150/1094/1028/970/925/886/830		1380/1290/1205/1100/1033/955/870
Sound pressure level ⁴	dB(A)	41/39/37/35/33/32/31		44/42/40/39/37/35/33
Sound power level	dB(A)	59/57/55/53/51/50/49		62/60/58/57/55/53/51
Unit	Net dimensions ⁵ (WxHxD)	mm 1340×545×212		
	Packed dimensions (WxHxD)	mm 1425×639×345		
	Net/Gross weight	kg 30.5/35.5		32/37
Pipe connections	Liquid/Gas pipe	mm Φ9.53/Φ15.9		
	Drain pipe	mm Φ16		

Notes:

1. Indoor temperature 27°C DB, 19°C WB; outdoor temperature 35°C DB; equivalent refrigerant piping length 7.5m with zero level difference.
2. Indoor temperature 20°C DB; outdoor temperature 7°C DB, 6°C WB; equivalent refrigerant piping length 7.5m with zero level difference.
3. Each model's 7 airflow rate options are listed in order, from highest to lowest.
4. Each model's 7 sound pressure levels are listed in order from highest to lowest and correspond to the model's 7 airflow rate options (see Note 3).
Sound pressure level is measured 1m in front and 1m above the floor in a semi-anechoic chamber.
5. Unit body dimensions given are the largest external dimensions of the unit, including hanger attachments.
All specifications are measured at 10Pa external static pressure.

Floor Standing Unit (Exposed)

- The F4 (front air intake) and F5 (underside air intake) offer a choice of air intake options



Model		MI2-22F4DN1 MI2-22F5DN1	MI2-28F4DN1 MI2-28F5DN1
Power supply		1 phase, 220-240V, 50Hz	
Cooling ¹	Capacity	kW 2.2	2.8
	Power input	kBtu/h 7.5	9.6
Heating ²	Capacity	kW 2.4	3.2
	Power input	kBtu/h 8.2	10.9
Air flow rate ³		m ³ /h 530/504/478/456/439/418/400	
Sound pressure level ⁴		dB(A) 36/35/34/33/31/30/29	
Sound power level		dB(A) 54/53/52/51/49/48/47	
Unit	Net dimensions ⁵ (WxHxD)	mm (F4) 1000x596x225	
		mm (F5) 1000x677x220	
	Packed dimensions (WxHxD)	mm (F4) 1089x683x312	
		mm (F5) 1182x683x312	
Net/Gross weight		kg (F4) 28/33	
		kg (F5) 28/35	
Pipe connections	Liquid/Gas pipe	mm Φ6.35/Φ12.7	
	Drain pipe	mm Φ16	

Model		MI2-36F4DN1 MI2-36F5DN1	MI2-45F4DN1 MI2-45F5DN1
Power supply		1 phase, 220-240V, 50Hz	
Cooling ¹	Capacity	kW 3.6	4.5
	Power input	kBtu/h 12.3	15.4
Heating ²	Capacity	kW 4.0	5.0
	Power input	kBtu/h 13.6	17.1
Air flow rate ³		m ³ /h 624/591/557/522/473/420/375	
Sound pressure level ⁴		dB(A) 37/36/35/34/32/31/30	
Sound power level		dB(A) 55/54/53/52/51/49/48	
Unit	Net dimensions ⁵ (WxHxD)	mm (F4) 1200x596x225	
		mm (F5) 1200x677x220	
	Packed dimensions (WxHxD)	mm (F4) 1289x683x312	
		mm (F5) 1382x683x312	
Net/Gross weight		kg (F4) 33/38.6	
		kg (F5) 33/40.7	
Pipe connections	Liquid/Gas pipe	mm Φ6.35/Φ12.7	
	Drain pipe	mm Φ16	

Model		MI2-56F4DN1 MI2-56F5DN1	MI2-71F4DN1 MI2-71F5DN1	MI2-80F4DN1 MI2-80F5DN1
Power supply		1 phase, 220-240V, 50Hz		
Cooling ¹	Capacity	kW 5.6	7.1	8.0
	Power input	kBtu/h 19.1	24.2	27.3
Heating ²	Capacity	kW 6.3	8.0	9.0
	Power input	kBtu/h 21.5	27.3	30.7
Air flow rate ³		m ³ /h 1150/1094/1028/970/925/886/830		
Sound pressure level ⁴		dB(A) 41/39/37/35/33/32/31		
Sound power level		dB(A) 59/57/55/53/51/50/49		
Unit	Net dimensions ⁵ (WxHxD)	mm (F4) 1500x596x225		
		mm (F5) 1500x677x220		
	Packed dimensions (WxHxD)	mm (F4) 1589x683x312		
		mm (F5) 1682x683x312		
Net/Gross weight		kg (F4) 40/46		41.5/47.5
		kg (F5) 40.4/48.6		41.5/49.5
Pipe connections	Liquid/Gas pipe	mm Φ9.53/Φ15.9		
	Drain pipe	mm Φ16		

- Notes:
- Indoor temperature 27°C DB, 19°C WB; outdoor temperature 35°C DB; equivalent refrigerant piping length 7.5m with zero level difference.
 - Indoor temperature 20°C DB; outdoor temperature 7°C DB, 6°C WB; equivalent refrigerant piping length 7.5m with zero level difference.
 - Each model's 7 airflow rate options are listed in order, from highest to lowest.
 - Each model's 7 sound pressure levels are listed in order from highest to lowest and correspond to the model's 7 airflow rate options (see Note 3). Sound pressure level is measured 1m in front and 1m above the floor in a semi-anechoic chamber.
 - Unit body dimensions given are the largest external dimensions of the unit, including hanger attachments.

Console

- Combination of four air inlets and two air outlets ensures that cooling and heating are distributed in all directions.

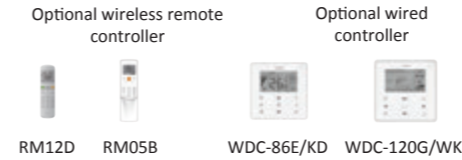

Model		MI2-22ZDN1	MI2-28ZDN1	MI2-36ZDN1	MI2-45ZDN1
Power supply		1 phase, 220-240V, 50Hz			
Cooling ¹	Capacity	kW 2.2	2.8	3.6	4.5
	Power input	kBtu/h 7.5	9.6	12.3	15.4
Heating ²	Capacity	kW 2.6	3.2	4.0	5.0
	Power input	kBtu/h 8.9	10.9	13.4	17.1
Air flow rate ³		m ³ /h 430/401/374/345/302/268/229			
Sound pressure level ⁴		dB(A) 38/36/34/32/28/27/26			
Sound power level		dB(A) 54/52/50/48/44/43/42			
Unit	Net dimensions ⁵ (WxHxD)	mm 700x600x210			
	Packed dimensions (WxHxD)	mm 810x710x305			
	Net/Gross weight	kg 14/19		15/20	
Pipe connections	Liquid/Gas pipe	mm Φ6.35/Φ12.7			
	Drain pipe	mm OD Φ16			

- Notes:
- Indoor temperature 27°C DB, 19°C WB; outdoor temperature 35°C DB; equivalent refrigerant piping length 7.5m with zero level difference.
 - Indoor temperature 20°C DB; outdoor temperature 7°C DB, 6°C WB; equivalent refrigerant piping length 7.5m with zero level difference.
 - Each model's 7 airflow rate options are listed in order, from highest to lowest.
 - Each model's 7 sound pressure levels are listed in order from highest to lowest and correspond to the model's 7 airflow rate options (see Note 3). Sound pressure level is measured 1m in front and 1m above the floor in a semi-anechoic chamber.
 - Unit body dimensions given are the largest external dimensions of the unit, including hanger attachments.

CONTROL SOLUTIONS

47

Wireless Remote
Controllers

51

Wired
Controllers

55

Centralized
Controllers

61

Data Converter

67

Network
Control System

73







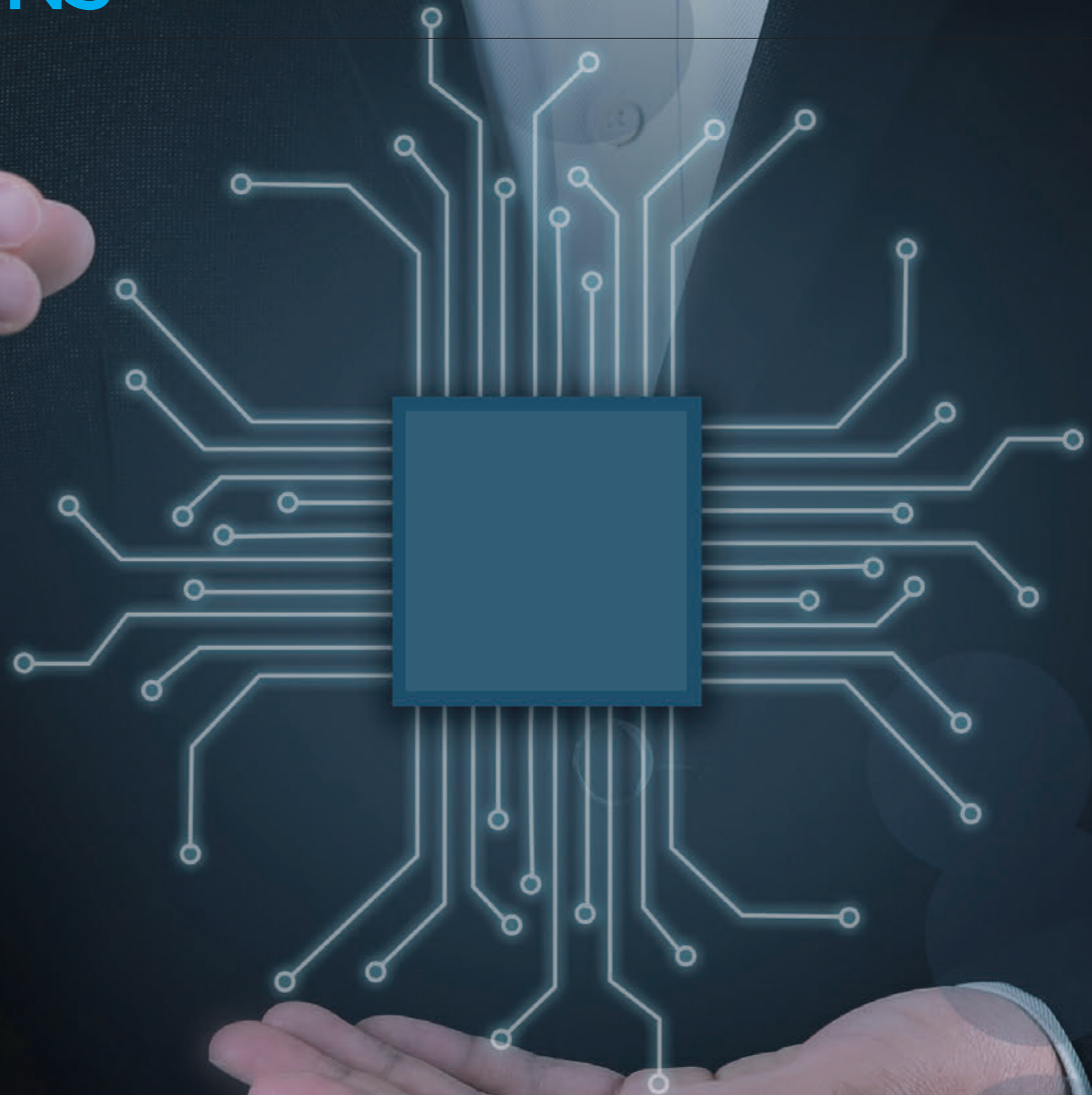









BMS Gateways

81

Accessories





CONTROLLER LINEUP

Wireless Remote/ Wired Controllers	Centralized Controllers	Data converter	Network Control System	BMS Gateways	Accessories
<p>RM05B RM12D</p> 	<p>CCM-180A/WS</p> 	<p>CCM-15</p> 	<p>IMMP-M + IMMP-S</p> 	<p>GW-BAC or IMMP-BAC</p> 	<p>Hotel Key Card Interface Module MD-NIM05/E MD-NIM05B/E</p> 
<p>WDC-86E/K</p> 	<p>CCM-270A/WS</p> 		<p>IMMP-BAC + IMMP-S</p> 	<p>GW-LON</p> 	<p>Infrared Sensor Controller MD-NIM09</p> 
<p>WDC-86E/KD</p>  <p>WDC-120G/WK</p> 			<p>CCM-270A/WS + IMMP-S</p> 	<p>GW-MOD</p> 	<p>Diagnosis software MCAC-DIAG-B</p> 

Wireless Remote Controllers



Features

Model	 RM05B	 RM12D
On / Off	●	●
Mode selection	●	●
Temperature setting	● (0.5°C or 1°C steps)	● (0.5°C or 1°C steps)
7-speed fan control	●	●
Auto swing	●	●
5-step swing louver	●	●
Address setting	●	●
Follow me	—	●
Eco mode	●	●
Night silent mode	●	●
Display shut-off	●	●
Daily timer	●	●
Keyboard lock	●	●
Background light	●	●
Dimensions (H×W×D) (mm)	150×65×20	170×48×20
Batteries	1.5V (LR03/AAA) × 2	

Temperature Setting

Set temperature can be adjusted in 0.5°C or 1°C steps, enabling precise comfort control.

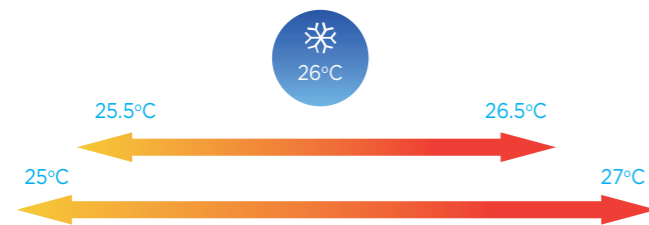

7-Speed Fan Control

7 indoor fan speeds provide control flexibility to meet the needs of different indoor conditions.

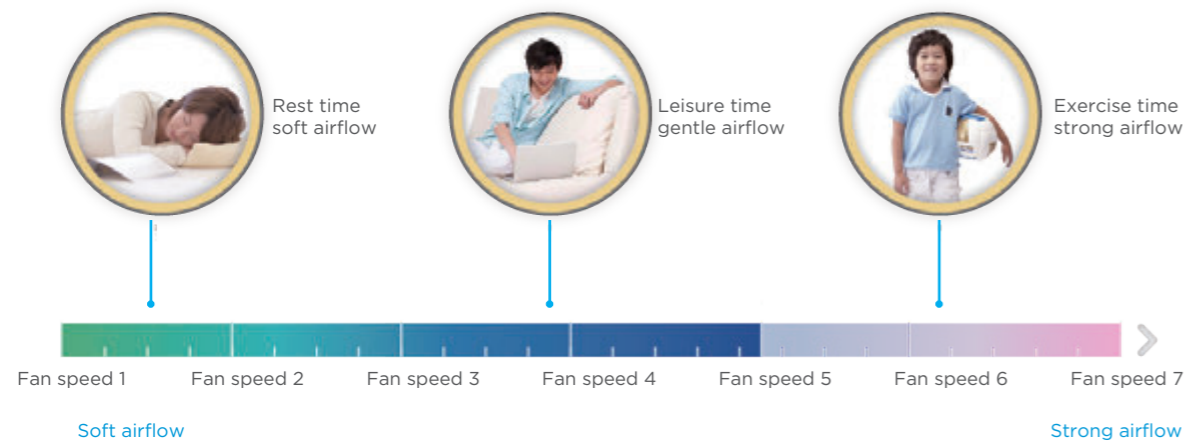

Display Shut-off

Indoor unit displays can be shut off at night, creating a better environment for rest.



5-step Swing Louver

The air is comfortably spread upwards and downwards thanks to the 5-step swing louver that can be programmed via the controller.

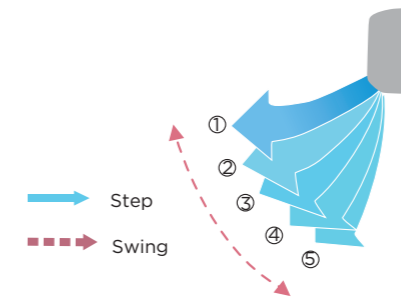

Follow Me

With the follow me function, the indoor unit responds to the temperature measured by the temperature sensor built-in to the wireless remote controller, rather than the temperature sensor in the indoor unit itself, enabling more precise control of the temperature in the user's immediate environment.



Eco Mode

Eco mode saves energy whilst retaining a comfortable indoor environment.



Wired Controllers



Features

Model	 WDC-86E/KD	 WDC-86E/K	 WDC-120G/WK
On / Off	●	●	●
Mode selection	●	●	●
Temperature setting	● (0.5°C or 1°C steps)	● (0.5°C or 1°C steps)	● (0.5°C or 1°C steps)
Dual temperature set points	●	—	●
7-speed fan control	●	●	●
Auto swing	●	●	●
5-step swing louver	●	●	●
Address setting	●	●	●
Follow me	●	●	●
Eco mode	●	●	●
Room temperature display	●	—	●
°F/°C display	●	●	●
Keyboard lock	—	—	●
Background light	●	●	●
Daily timer	●	●	●
Weekly schedule timer	—	—	●
Auto restart	●	●	●
2 permission levels	—	—	●
Bi-directional communication	●	—	●
Group control	—	—	●
Main or secondary controller setting	●	—	●
Display shut-off	●	●	●
Night silent mode	●	●	●
Remote signal receiver	●	●	●
Clean filter reminder	●	●	●
Extension function	—	—	●
Daylight saving time	—	—	●
Clock display	—	—	●
Dot matrix display	—	—	●
Error check function	●	—	●
System parameter querying	●	—	●
System setting control	●	—	●
Dimensions (WxHxD) (mm)	86x86x18	86x86x18	120x120x20
Power supply	18V DC	5V DC	18V DC

Group Control

One controller can be used to unify the settings across up to 16 indoor units.



Main or Secondary Controller Setting

Two controllers can be used together, with the indoor units' operating mode and settings being set according to the most recent instruction received. The controller display screens are synchronized so that both displays update when a setting is adjusted.

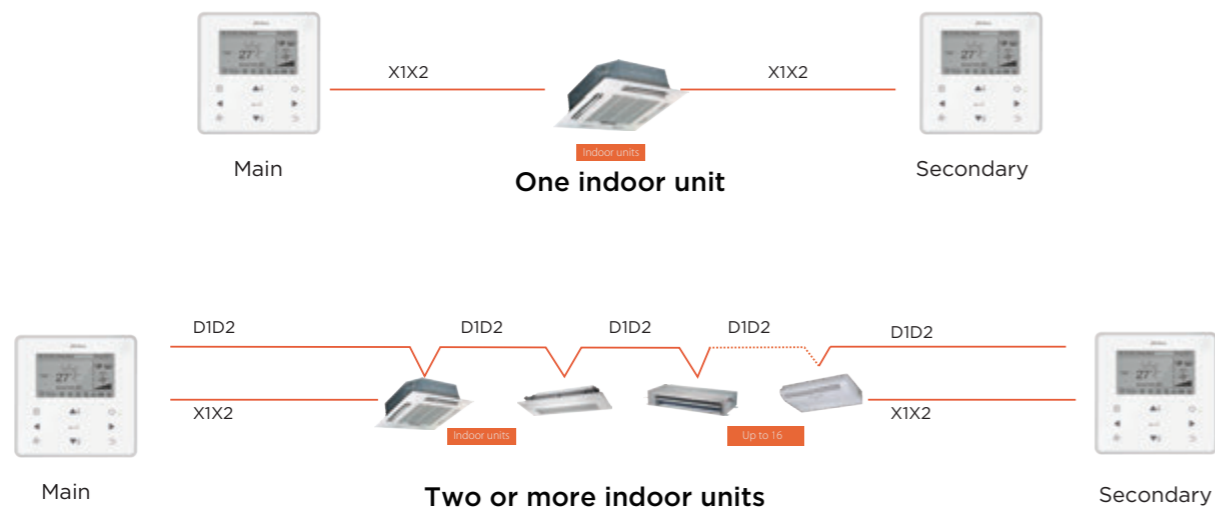

2 Permission Levels

2 permission levels ensure users can easily access control functions and allow administrators convenient access to operating parameters.

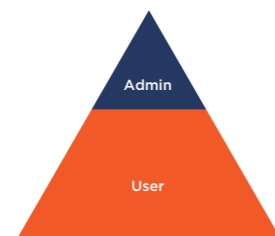

Extension Function

The extension function is specifically designed for users working overtime. Pressing the delay button postpones system shutdown by 1 or 2 hours.



Dual Temperature Set Points

With dual temperature set point control, the set temperature changes automatically when the operating mode is changed.

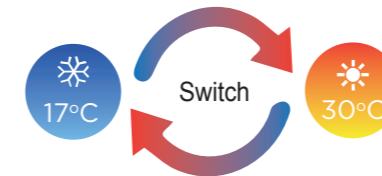

Weekly Schedule Timer

The weekly schedule timer allows users to set multiple schedules each with its own operating mode, temperature settings and fan speeds.

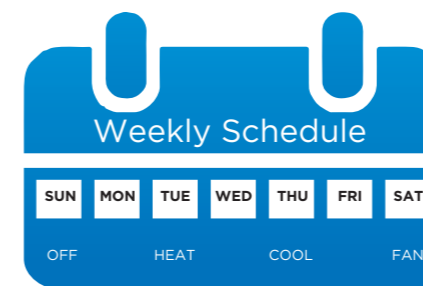

Bi-directional Communication

The wired controller can query the system operating parameters thanks to the new bi-directional communication functionality. In addition, settings including static pressure, cold draft prevention and temperature compensation can be configured on the wired controller.



Centralized Controllers



Features

Model	 CCM-180A/WS	 CCM-270A/WS
Max. number of indoor units	64	384
Max. number of refrigerant systems	8	48
Touch screen	● (6.2-inch)	● (10.1-inch)
On / Off	●	●
Mode selection	●	●
Temperature setting	● (0.5°C or 1°C steps)	● (0.5°C steps)
7-speed fan control	●	●
Auto swing	●	●
5-step swing louver	—	●
Room temperature display	—	●
Outdoor unit Eco mode setting	●	●
Holiday setting	●	●
°C/°F display	●	●
Schedule management	●	●
Clock display	●	●
2 permission levels	●	●
Extension function	●	—
Daylight saving time	●	—
Unit model recognition	●	●
Electricity charge distribution	—	●
Visual schematic	—	●
Energy management	●	●
Group management	●	●
Error check function	●	●
System parameter querying	●	●
USB output		
Report display	Error report	Error report, operation record and electricity consumption report
Email output	—	●
Operation log	—	●
LAN access	—	●
languages supported	English	English
Dimensions (W×H×D) (mm)	181x124x30	270×183×27
Power supply	12V DC	24V AC

Touch Screen

Colorful touch screen and vivid display make operation more convenient and simple.



Electricity Charge Distribution

The controllers use the patented Midea Calculation Method to estimate the electricity consumption of the outdoor units and then divide it among the indoor units so that the electricity charges can be equitably divided among building occupants.

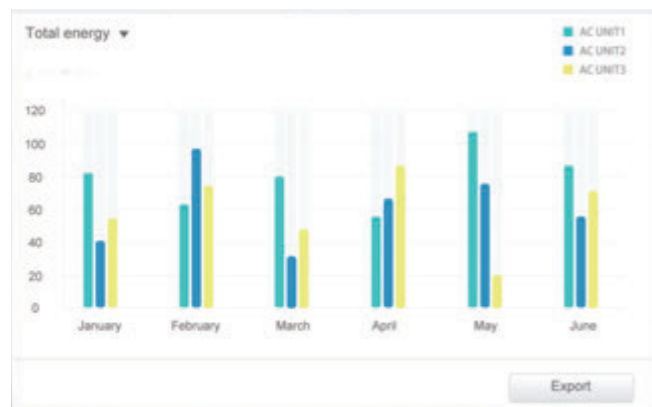

Energy Management

User can set limits or locks on an indoor unit, such as minimum cooling temperature, maximum heating temperature, fan speed, operation mode, swing lock, remote controller lock and wired controller lock.

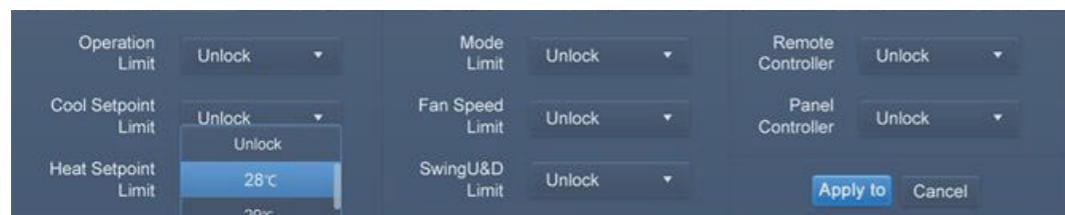

Visual Schematic

By importing floor plans and then dragging and dropping the indoor units to their actual positions on the floor plan, users can create a tailored system schematic which enables monitoring and control of the indoor units through a clear visual representation of the system layout.



Group Management

Units can be viewed according to group, system or location, making unit management clearer and more convenient.



Outdoor Unit Configuration

Outdoor unit configuration and settings can be monitored and controlled without having to go outdoors.



Unit Model Recognition

The controller recognizes the model of indoor and outdoor units and different models are represented by different icons.



Schedule Management

Daily, weekly or annual schedules can be used to set unit settings such as on/off, operating mode, set temperature, fan speed and swing.

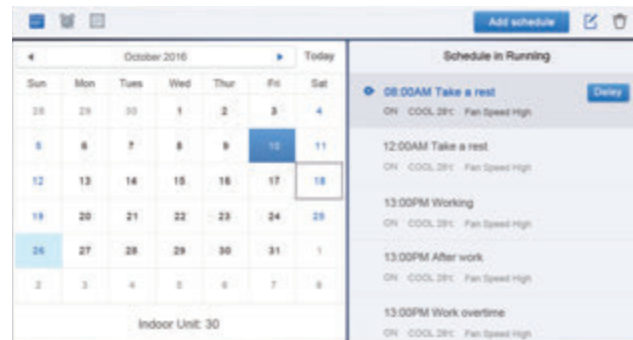

LAN Access

A desktop or laptop PC can be used for browser-based access via a LAN connection.



Wiring Flexibility

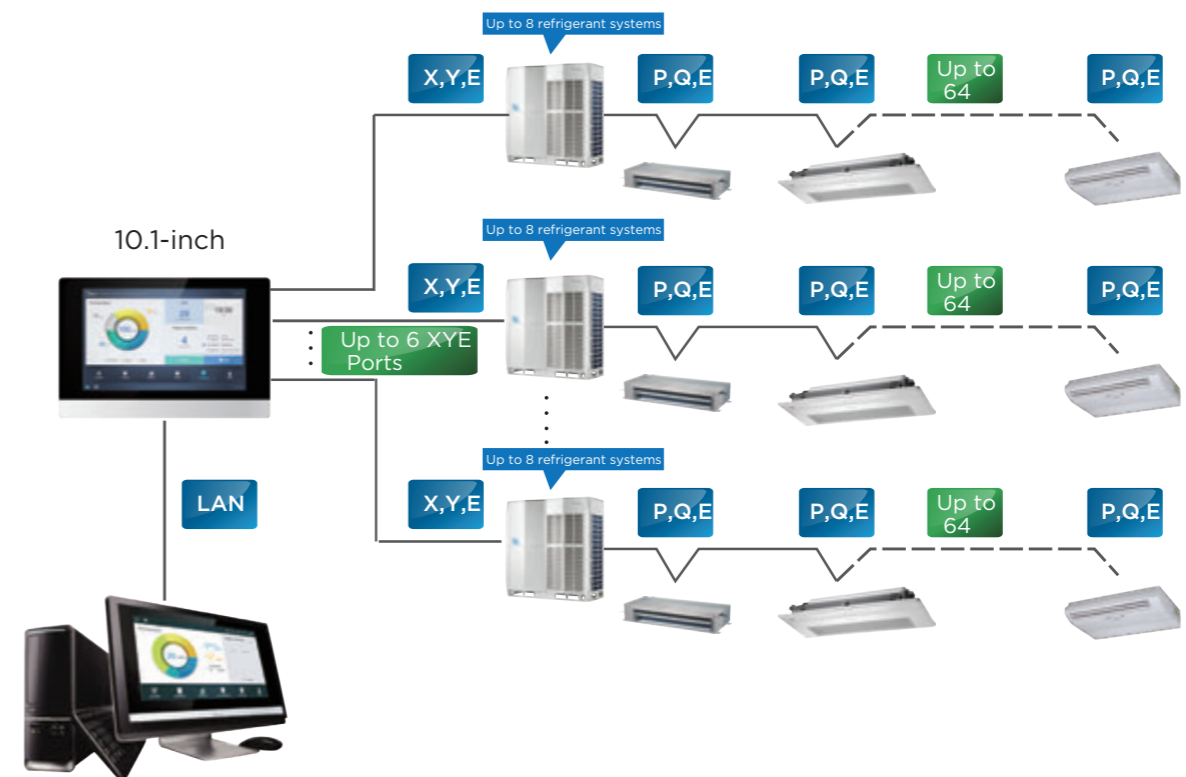
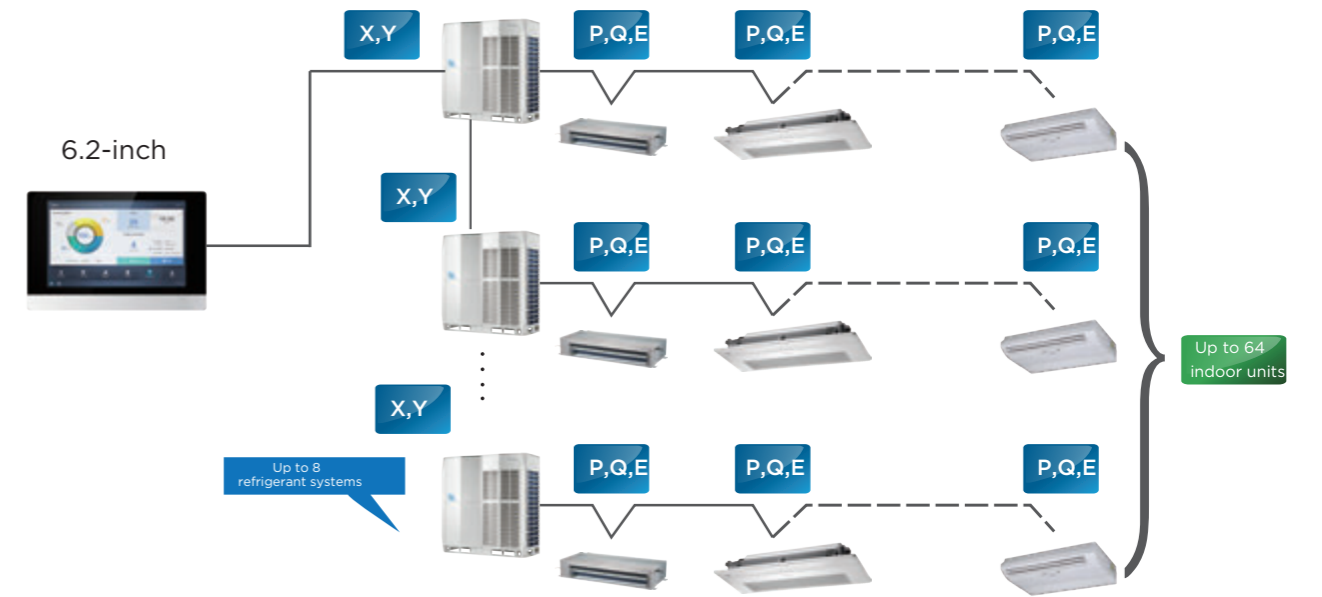

The controllers can be connected to the master outdoor unit directly.

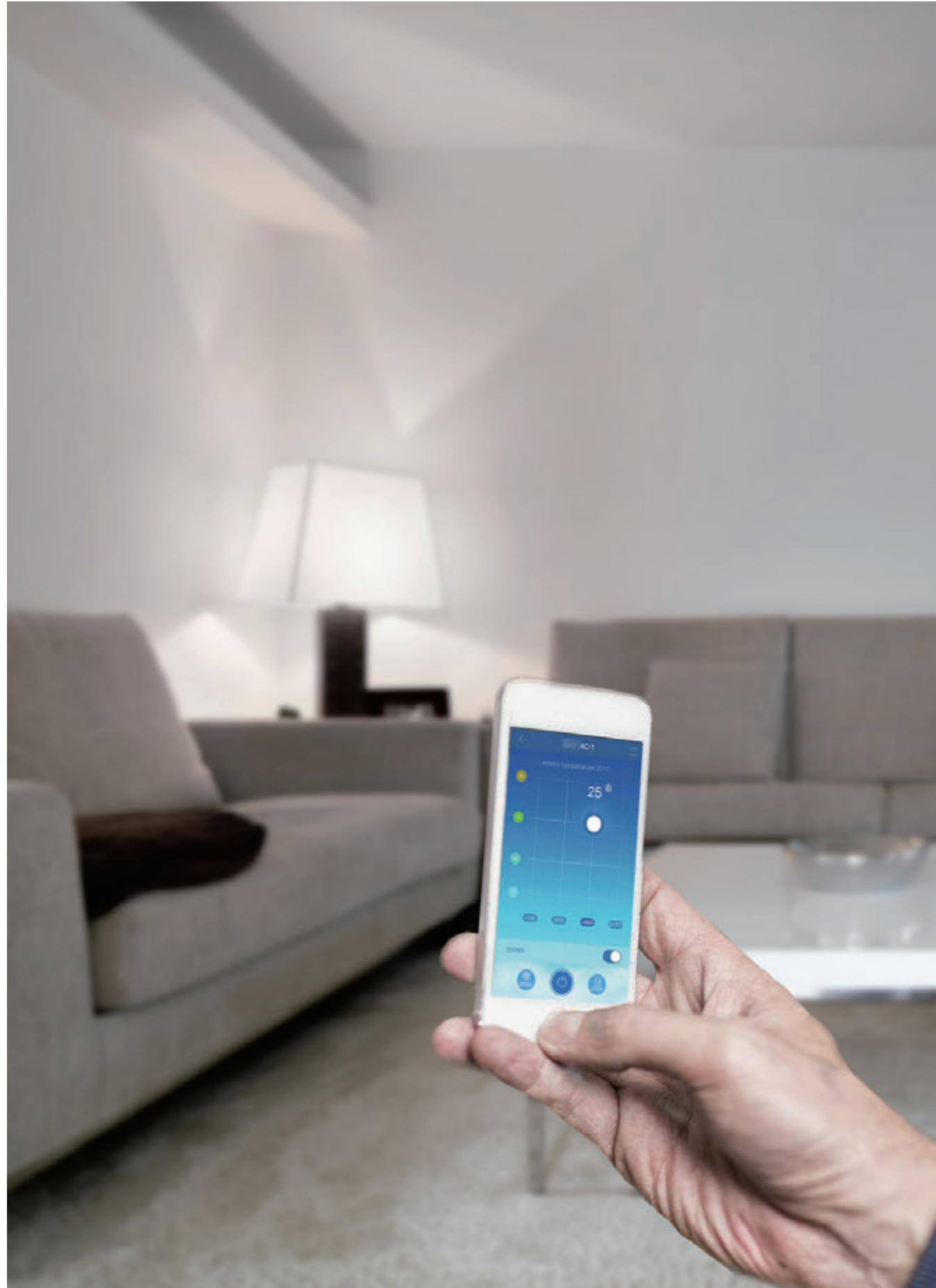

Data Converter



Features

Hardware model	 CCM-15	
Application scenarios	 Mobile Phone Application	 Cloud Server Website
Max. number of CCM-15 for one mobile APP	10	10
Max. number of indoor units	640	640
Max. number of refrigerant systems	80	80
On/Off	●	●
Mode selection	●	●
Temperature setting	● (1°C steps)	● (1°C steps)
7-speed fan control	—	—
Auto swing	●	●
5-step swing louver	—	—
Room temperature display	●	●
°C/°F display	●	●
Weekly timer	●	●
Indoor unit type recognition	—	—
Energy management	●	●
Group management	●	●
User group management	●	●
Operation log	●	●
Device log	●	●
Login record	●	●
Error log	—	●
Configuration	●	—
Account registration	●	—
Virtual	●	—
Mode display	●	●
Languages supported	English, French, Spanish	English, French, Spanish
Dimensions (W×H×D) (mm)	187×115×28	
Power supply	1 phase, 100-240V, 50/60Hz	

High Compatibility

Compatible with a variety of operating systems.



User Friendly Interface

Clear, stylish interface designed by leading industrial designers.



Cloud Server Website

In addition to "M-control", users can control air conditioners and query the status of air conditioning equipment anytime and anywhere through the cloud server website.

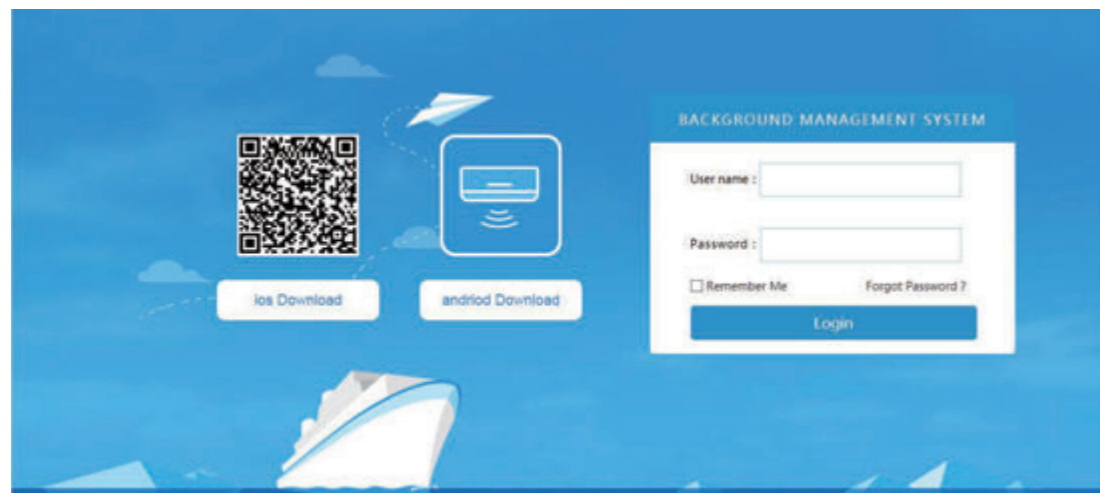

Virtual Experience

After downloading "M-control", you can experience the operation of the interface through the virtual experience function without registration.

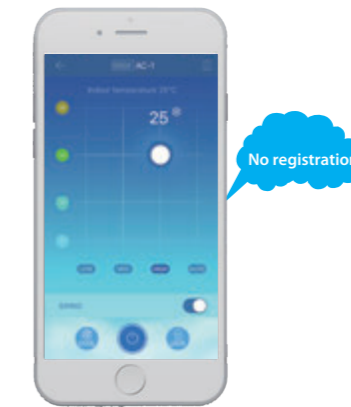

Easy Configuration

User groups can be joined simply by scanning a QR code.



Convenient Operation

Drag the position of the floating bubbles to change temperature and fan speed.



Anytime Control

Remote access to CCM-15 allows anytime, anywhere control.



Clear Icons

Clear, color-coded icons allow unit operating states to be viewed at a glance.



Group Management

The user can group the air conditioners equipment, and the air conditioner in the same group can be controlled together just with one tap.



2 Permission Levels

Administrators can set different permissions for different users to facilitate better management of devices.

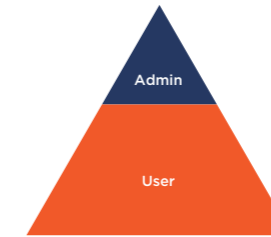

Multiple Language Options

Supports multiple languages so that users of different languages can operate easily.



Flexibility

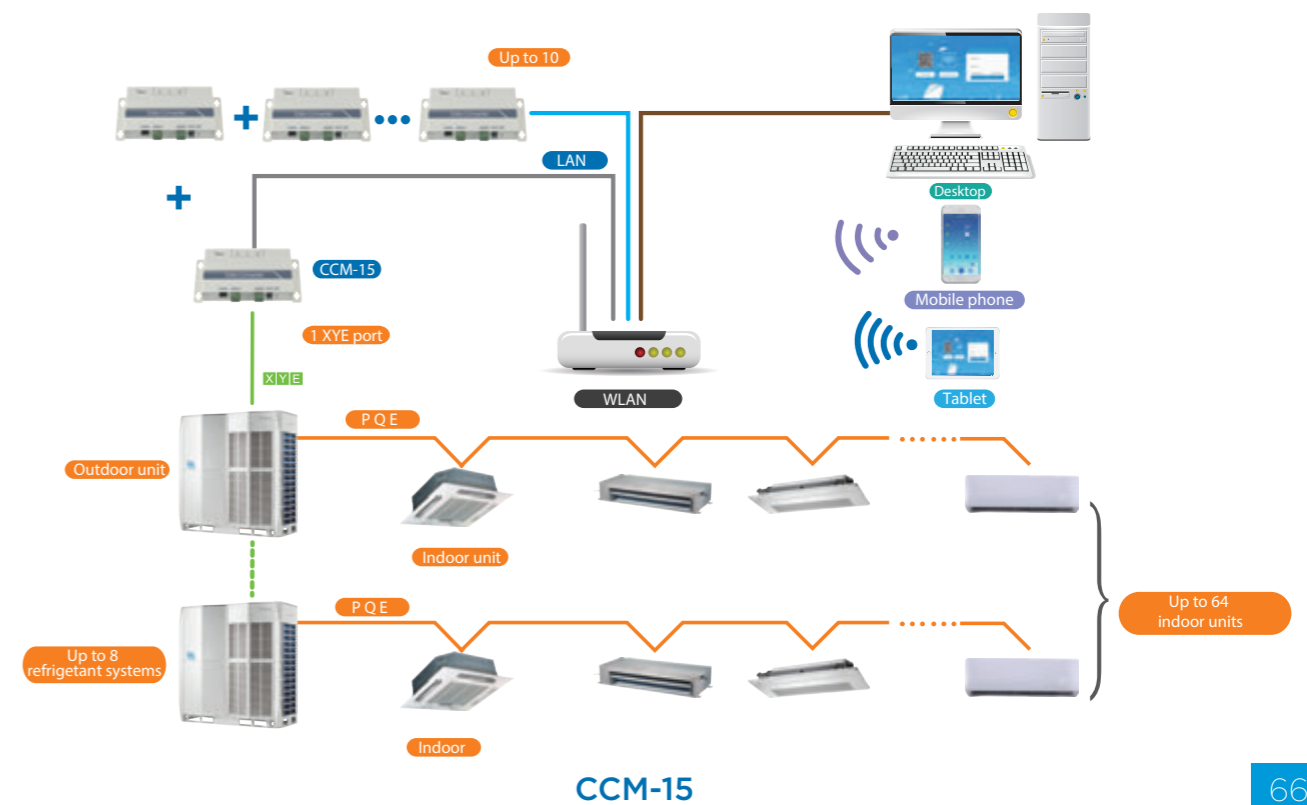

The Data Converter can be connected directly to a network of indoor/outdoor units.



Network Control System



Features

Software model	 IMMP-S		
Hardware model	 IMMP-M	 IMMP-BAC	 CCM-270A/WS
Max. number per IMMPRO system	10	10	
Max. number of indoor units	2560	3840	
Max. number of refrigerant systems	320	480	
Temperature setting	● (0.5°C steps)	● (0.5°C steps)	
Dual temperature set points	●	●	
7-speed fan control	●	●	
Auto swing	●	●	
5-step swing louver	●	●	
Outdoor unit Eco mode setting	●	●	
Holiday setting	●	●	
Schedule management	●	●	
Clock display	●	●	
2 permission levels	●	●	
Unit model recognition	●	●	
Electricity charge distribution	●	●	
Visual schematic	●	●	
Energy management	●	●	
Group management	●	●	
Error check function	●	●	
System parameter querying	●	●	
Report output	●	●	
Operation log	●	●	
LAN access	●	●	
Data backup	●	●	
Remote VPN access	●	●	
Languages supported	English	English	
Dimensions (W×H×D) (mm)	251×319×66	270×183×27	
Power supply	1 phase, 100-240V, 50/60Hz	24V AC	

Note: the IMMP-BAC gateway has integrated the functions of IMMP-M gateway and GW-BAC gateway.

User-friendly Interface

Simple, practical user interface makes for a user-friendly experience even for first-time users.



Outdoor Unit Configuration

Outdoor unit configuration and settings can be monitored and controlled without having to go outdoors.

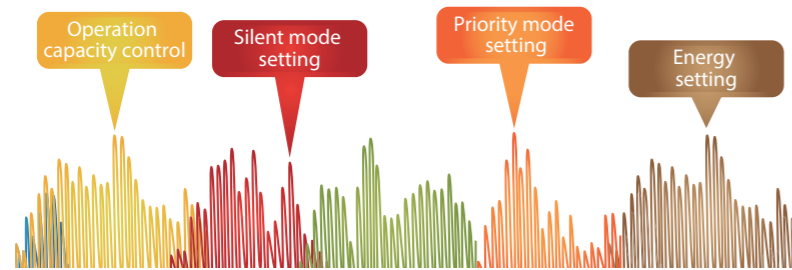

Electricity Charge Distribution

The IMMPRO uses the patented Midea Calculation Method to estimate the electricity consumption of the outdoor units and then divide it among the indoor units so that the electricity charges can be equitably divided among building occupants.

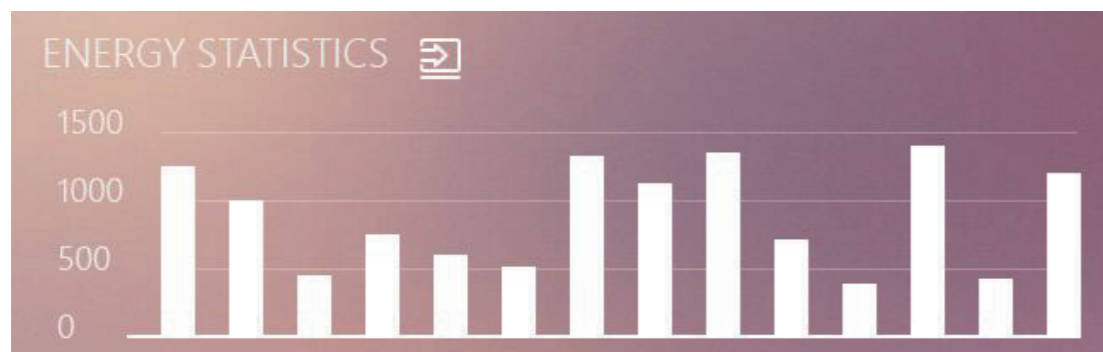

Public and Idle Devices

Marking a unit as a public device or idle device ensures the electricity charge distribution is more accurate and reasonable.

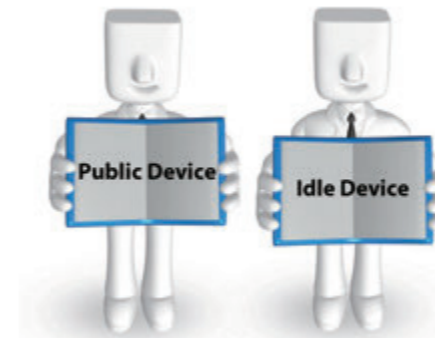

Visual Schematic

By importing floor plans and then dragging and dropping the indoor units to their actual positions on the floor plan, users can create a tailored system schematic which enables monitoring and control of the indoor units through a clear visual representation of the system layout.



Schedule Management

Daily, weekly or annual schedules can be used to set unit settings such as on/off, operating mode, set temperature, fan speed and swing.

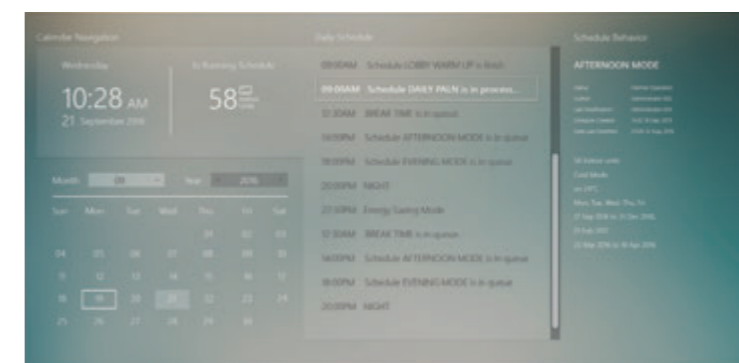

Xpress Installation

With the Xpress Installation wizard, IMMPRO can be installed quickly and easily without requiring support from a technical support engineer.

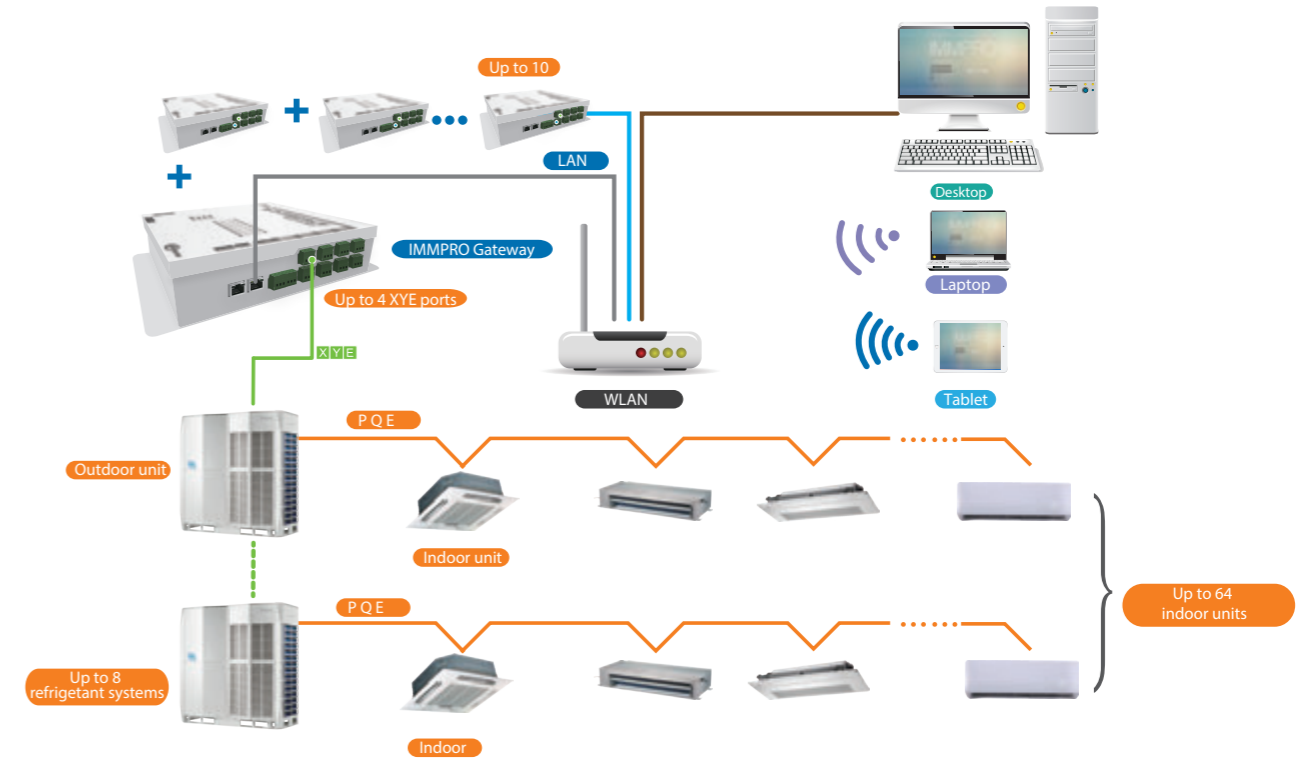

IMMMP-M

Network Flexibility

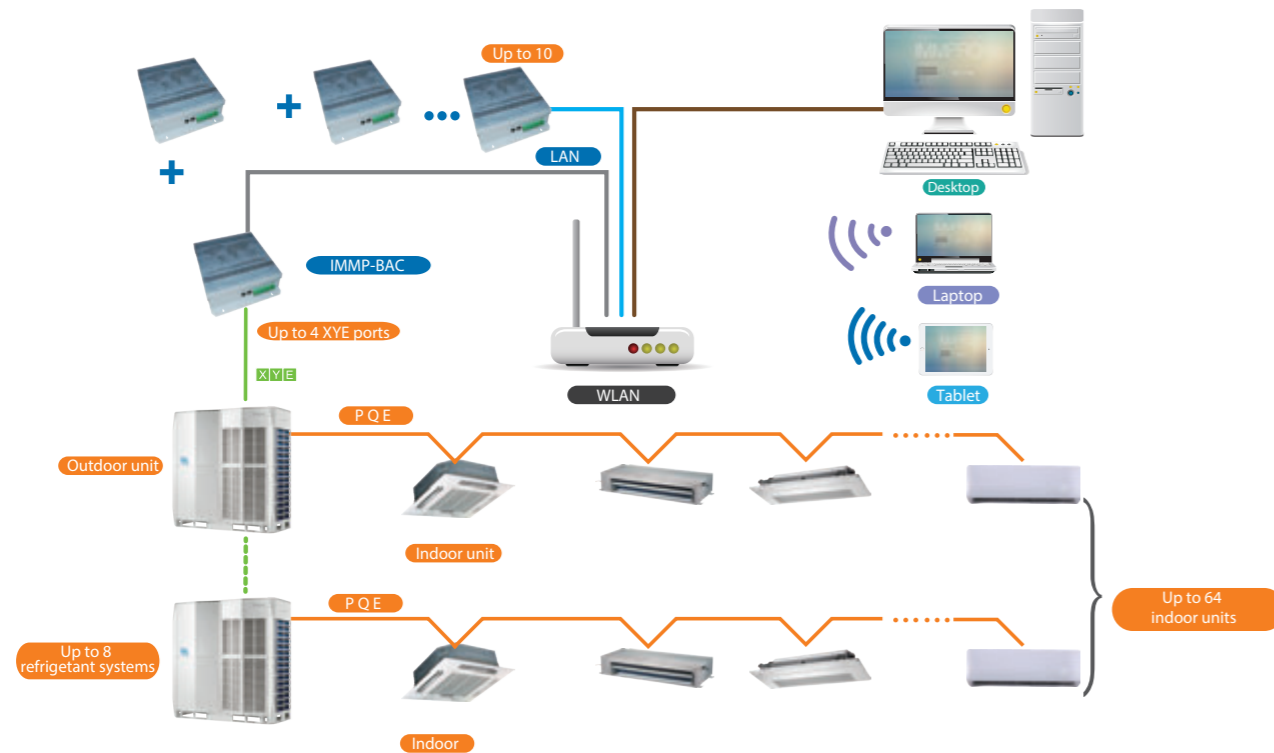

IMMMP-BAC

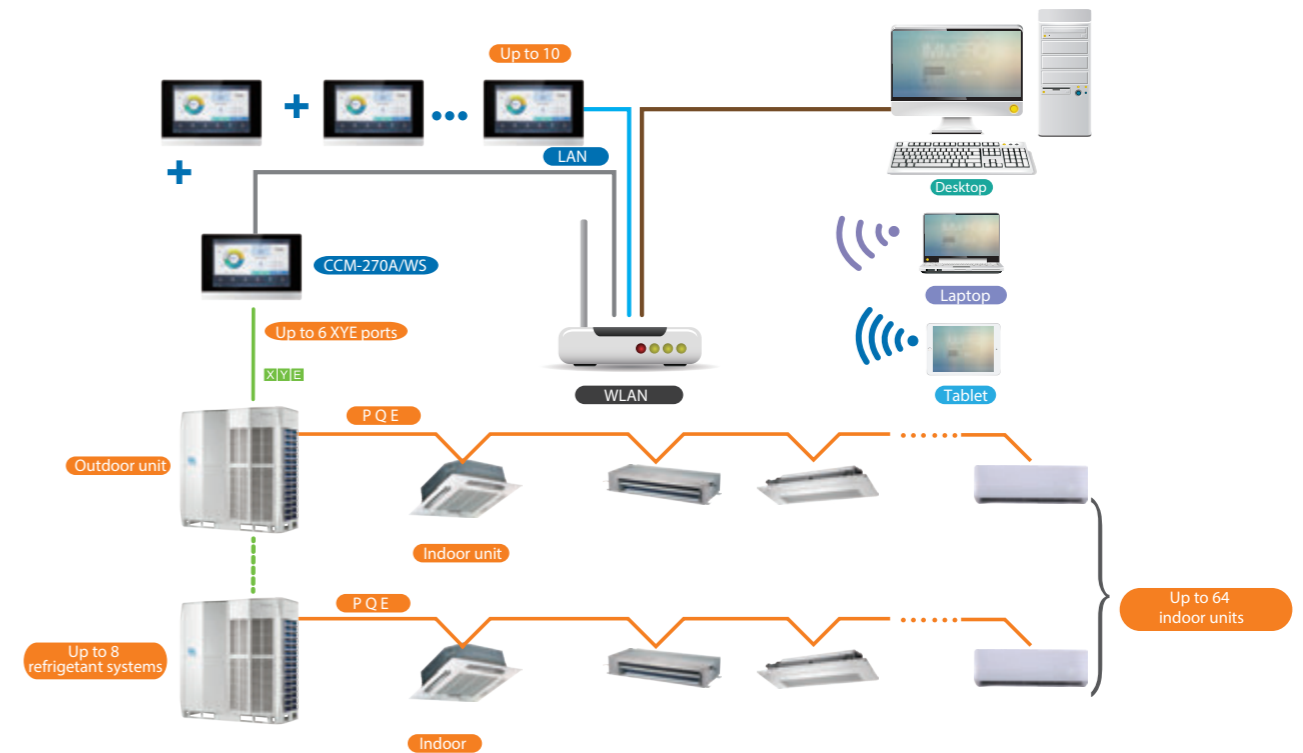

CCM-270A/WS

BMS Gateway

Monitoring and control of Midea's VRF air conditioners can be integrated into building management systems, enabling air conditioning to be monitored alongside lighting, power, fire, access and security systems. Midea's gateway devices provide full compatibility with the leading BMS protocols: BACnet, LonWorks and Modbus.





BACnet Gateway

GW-BAC or IMMP-BAC

Full Integration

The GW-BAC or IMMP-BAC Gateway allows Midea VRF systems to be monitored and controlled alongside other building management technology that use the BACnet protocol such as access control, fire detection and lighting systems.

Network Flexibility

The gateway can be connected to master outdoor units' X,Y,E ports directly.

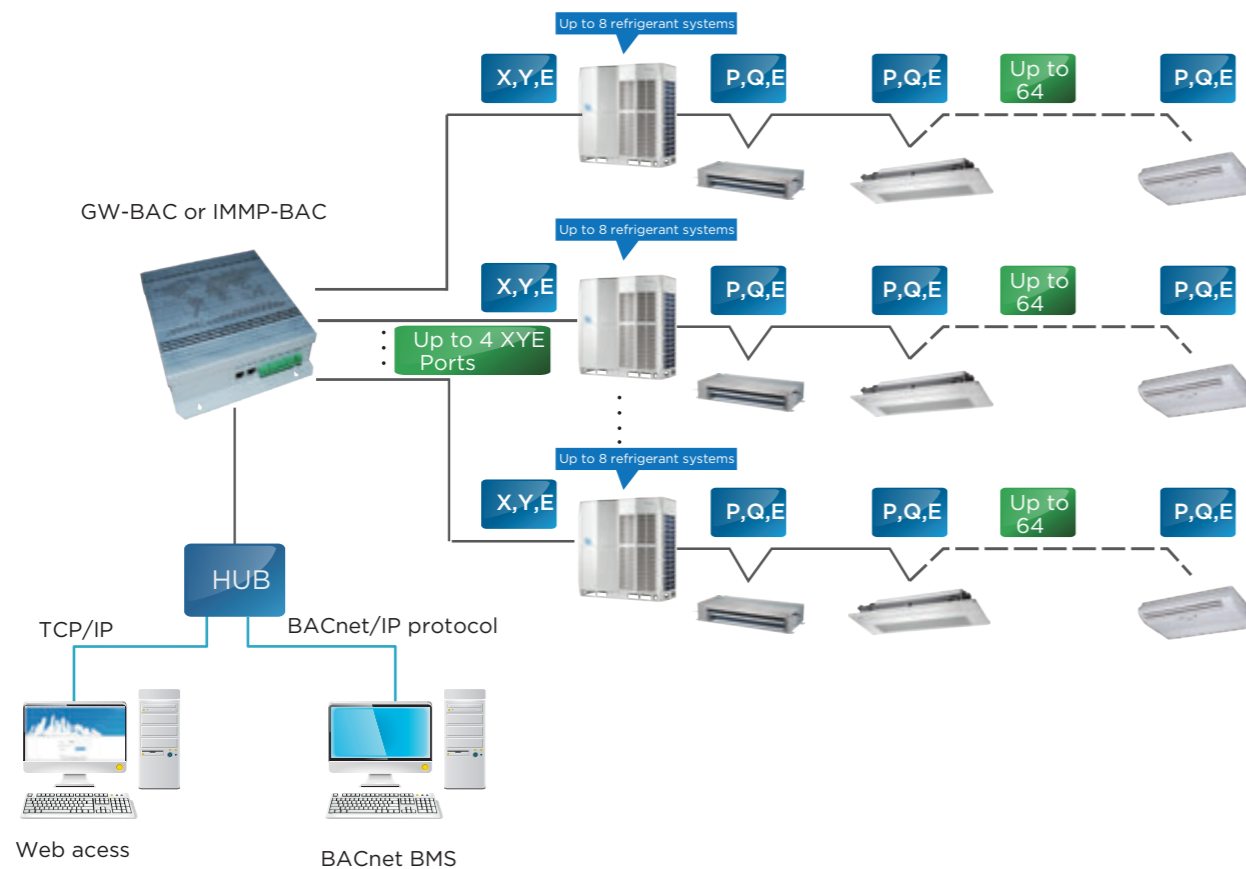

Features

Model	GW-BAC or IMMP-BAC		
Max. number of devices (include indoor and outdoor units)		256	
Max. number of refrigerant systems		32	
Control	On / Off	●	
	Mode selection	●	
	Temperature setting	●	
	Fan speed	●	
	Energy management	●	
Indoor unit monitoring	Room temperature display	●	
	Error status	●	
	Error alarms	●	
Outdoor unit monitoring	Operating mode	●	
	Outdoor ambient temperature	●	
	Fan speed	●	
	Compressor operating frequency	●	
	Discharge temperature	●	
	System pressure	●	
	Error status	●	
	Error alarms	●	
	LAN access		●
	BTL certification		●
Compatibility	Siemens	APOGEE	
	Trane	TRACER	
	Honeywell	ALERTON	
	Schneider	Andover Continuum	
	Johnson Controls	METASYS	
Dimensions (HxWxD)(mm)		319×251×61	
Power supply		1 phase, 100-240V, 50/60Hz	

Note: the IMMP-BAC gateway has integrated the functions of IMMP-M gateway and GW-BAC gateway.



GW-LON

LonWorks Gateway

Full Integration

The GW-LON Gateway allows Midea VRF systems to be monitored and controlled alongside other building management technology on the LonWorks platform such as security, fire safety and lighting systems.

Network Flexibility

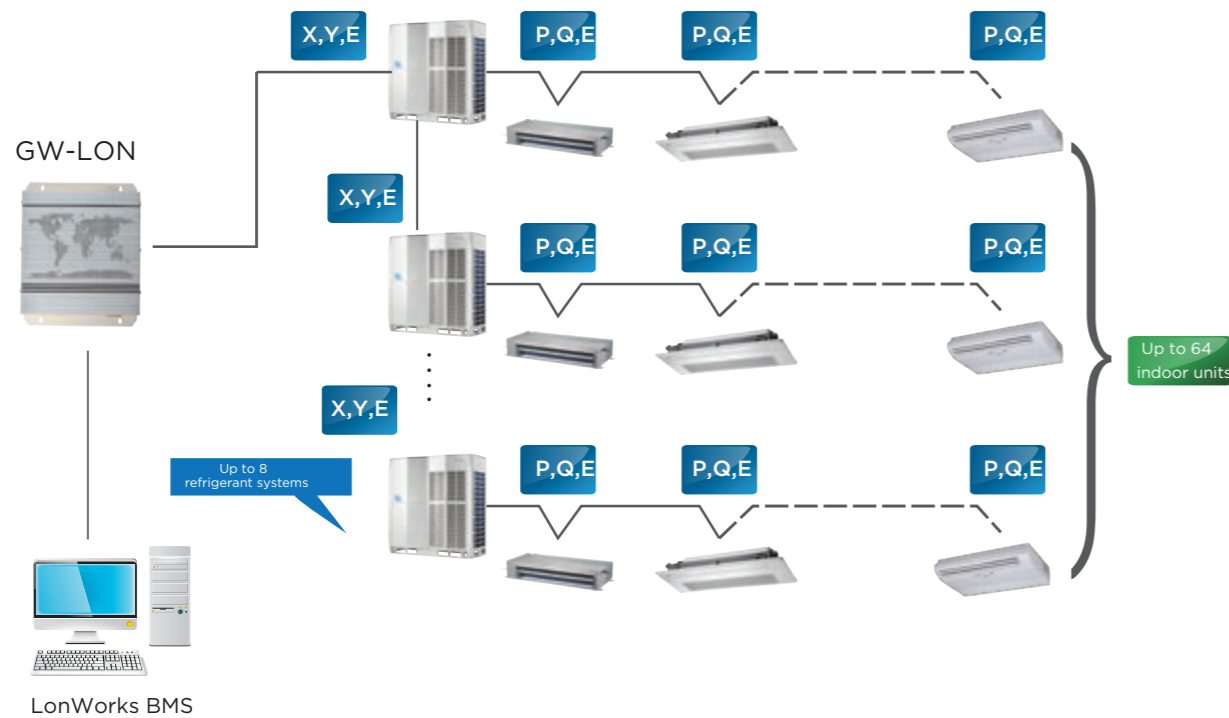

Features

Model	GW-LON	
Max. number of indoor units		64
Max. number of refrigerant systems		8
Control	Mode selection	●
	Temperature setting	●
	Fan speed	●
	Group shut down	●
	On / Off	●
Indoor unit monitoring	Operating mode	●
	Set temperature	●
	Fan speed	●
	Online status	●
	Operating status	●
	Room temperature	●
	Error status	●
Outdoor unit monitoring	Error status	●
Dimensions (HxWxD) (mm)	319×251×61	
Power supply	1 phase, 100-240V, 50/60Hz	

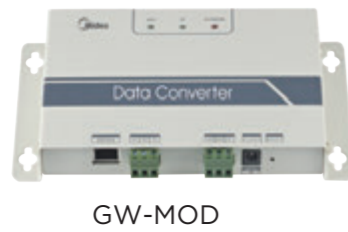

Modbus Gateway

Full Integration

The GW-MOD Gateway enables seamless connection of Midea VRF systems with building management systems built on the Modbus communication protocol.

Network Flexibility

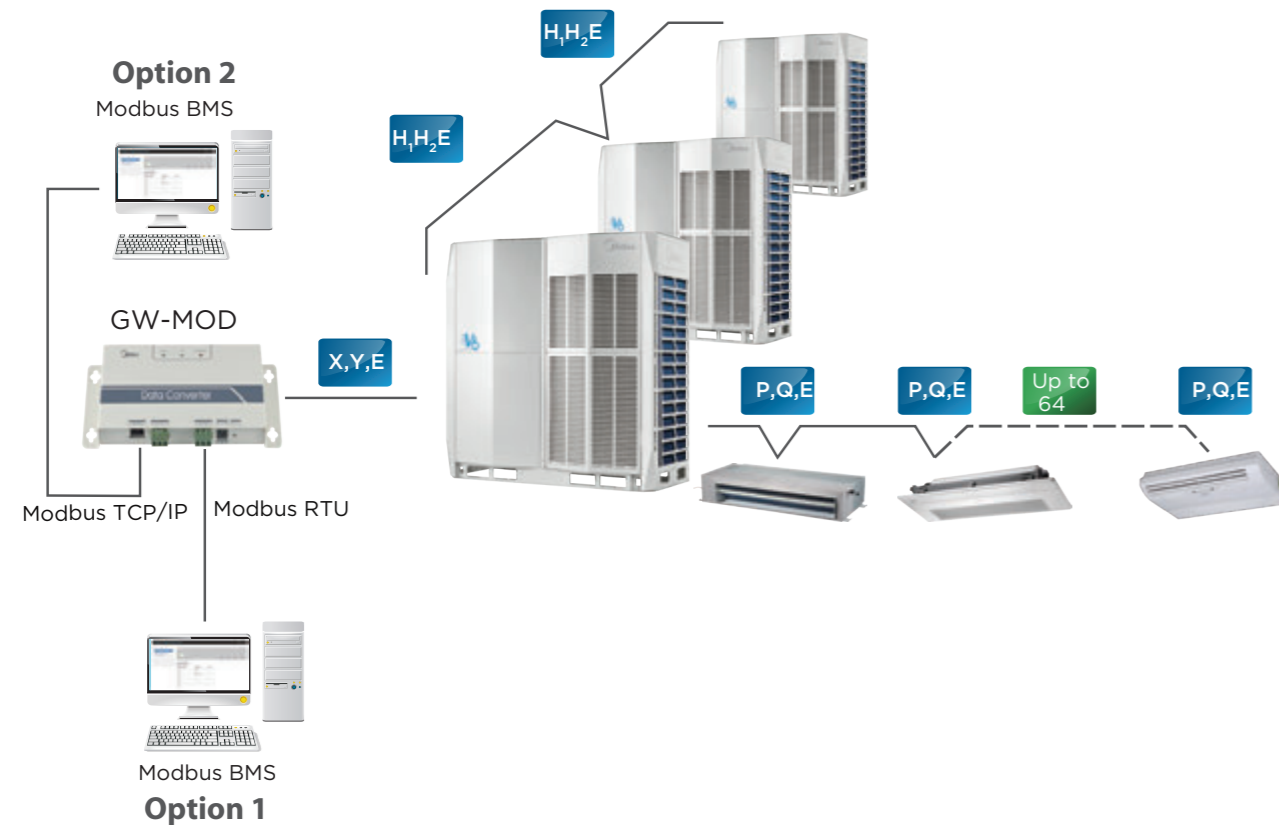

Features

Model	GW-MOD	
Max. number of indoor units		64
Max. number of refrigerant systems		1
Control	On / Off	●
	Mode selection	●
	Temperature setting	●
	Fan speed	●
	Group on/off	●
Indoor unit monitoring	Online status	●
	Room temperature	●
	Error status	●
	Operating mode	●
Outdoor unit monitoring	Operating mode	●
	Lock status	●
	Fan speed	●
	Set temperature	●
	Outdoor ambient temperature	●
	Error status	●
LAN access		●
Dimensions (HxWxD)(mm)		187x115x28
Power supply		1 phase, 100-240V, 50/60Hz



Hotel Key Card Interface Modules



Full Integration

The Hotel Key Card Interface Modules enable power supply to indoor units to be integrated with hotel key card power supply management systems, which are designed to save energy by only running appliances whilst guests are present in their room.

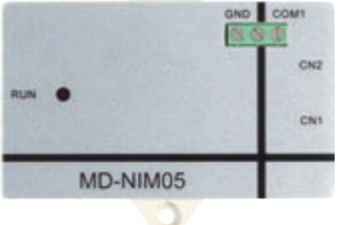
Features

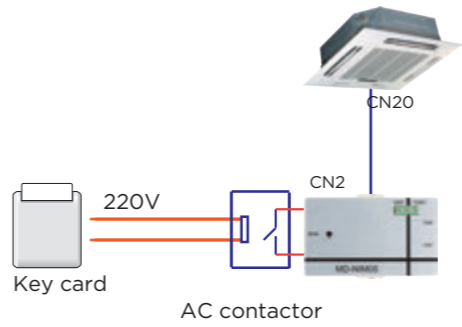
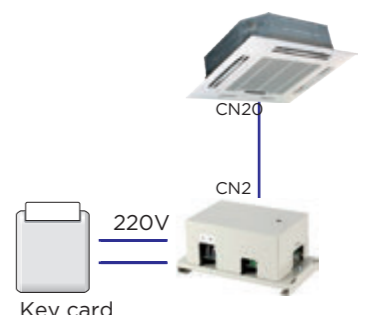
Model	MD-NIM05/E	MD-NIM05B/E
Appearance		
Network flexibility		
Auto restart	●	●
Compatibility	Remote and wired controller	Remote and wired controller
Dimensions (H×W×D) (mm)	15.5×86×72.8	87×150×70
Power supply	5V DC (Supplied by indoor unit)	1 phase, 100-240V, 50/60Hz

Note : The Hotel Key Card Interface Modules only compatible while using the infrared communication ports of wired Controllers.

Infrared Sensor Controller



Full Integration

Using infrared sensors to detect movement, the MD-NIM09 Infrared Sensor Controller automatically turns indoor units on or off upon sensing that the room is occupied or unoccupied. Suitable for hotels, offices, conference rooms and residences, the Infrared Sensor Controller ensures climate control whilst minimizing energy consumption.

Features

Model	MD-NIM09
Appearance	
Network flexibility	
Dimensions (H×W×D)(mm)	Sensor 46×30×25.6, Control box 86×72.8×15.5
Power supply	5V DC (Supplied by indoor unit)

Note : The Hotel Key Card Interface Modules only compatible while using the infrared communication ports of wired Controllers.

Diagnosis Software



Monitor and Diagnose

Midea's VRF Diagnosis Software tool is used to monitor VRF systems and diagnose system errors. System settings and operating parameters can be accessed easily and data logs can be reviewed for fault prevention purposes.

Features

Model	MCAC-DIAG-B	
Max. number of indoor units		64
Max. number of refrigerant systems		1
Control	Mode selection	●
	Temperature setting	●
	Fan speed	●
Outdoor unit monitoring	Operating mode	●
	Capacity	●
	Compressor operating frequency	●
	Operating current	●
	Error status	●
	Temperatures	T3,T4,Tp (See note 1)
	Valve statuses	SV4, SV5, SV6, ST1 (See note 2)
	EXV position	●
Indoor unit monitoring	Operating mode	●
	Capacity	●
	Fan speed	●
	Address	●
	Temperatures	T1, T2, T2B, TS (See note 3)
	EXV position	●
Error codes		●
Troubleshooting		●
Data logs		●
Diagrams	System schematic, refrigerant flow diagram, parameter chart	
Languages supported	English	

Notes:

1. Heat exchanger temperature, outdoor ambient temperature, discharge temperature.

2. Oil return valve, defrosting valve, EXV bypass valve, four-way valve.

3. Indoor ambient temperature, indoor heat exchanger mid-point temperature, indoor heat exchanger outlet temperature, set temperature.

Expert Diagnosis

Midea's VRF Diagnosis Software is specially designed to allow after-sales engineers, to understand the operating status of the system at a glance.



Use-friendly Interface

A stylish and simple interface with rich graphical representations makes diagnosing system issues quick and convenient.



Diagrams

A system schematic, refrigerant flow diagram and parameter chart can be generated to provide a graphical interpretation of the system status.

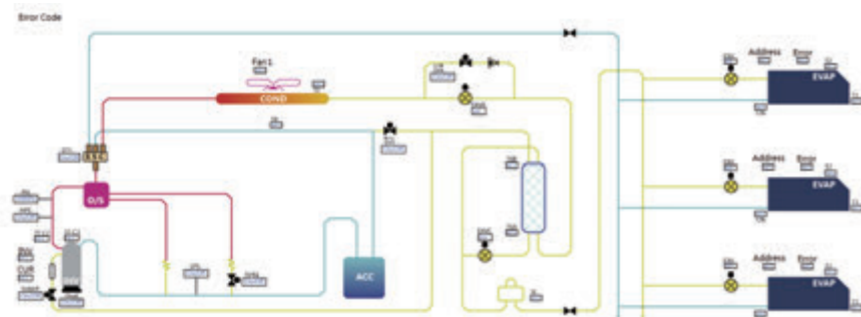

Parameter Querying

Access all the system parameters easily.



Data Logs

Data logs including operating records and error reports are saved by the software which is useful for discovering system issues.



Wiring Schematic

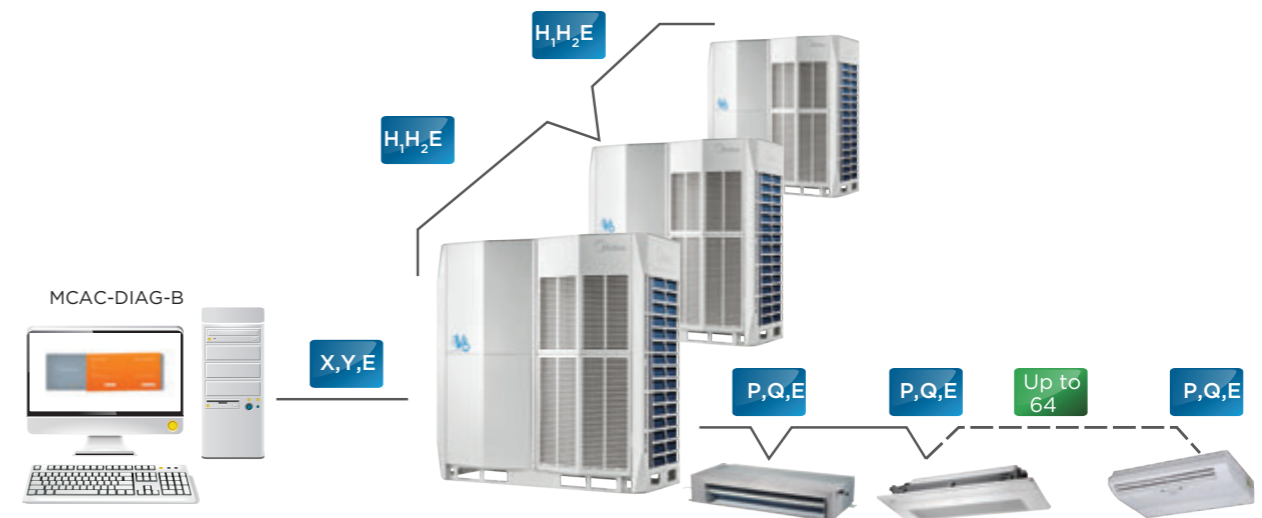

VRF AHU Control Box

High Efficiency

AHU Control Box facilitates raising the EER/COP of the complete AHU system.



Wide Capacity Range

Four Control Box can be used in parallel, giving an overall capacity range of 3.2HP to 80HP.



Compatible with All VRF Systems

AHU Control Box are compatible with all Midea VRF outdoor units and can be used together with all types of Midea VRF indoor units.

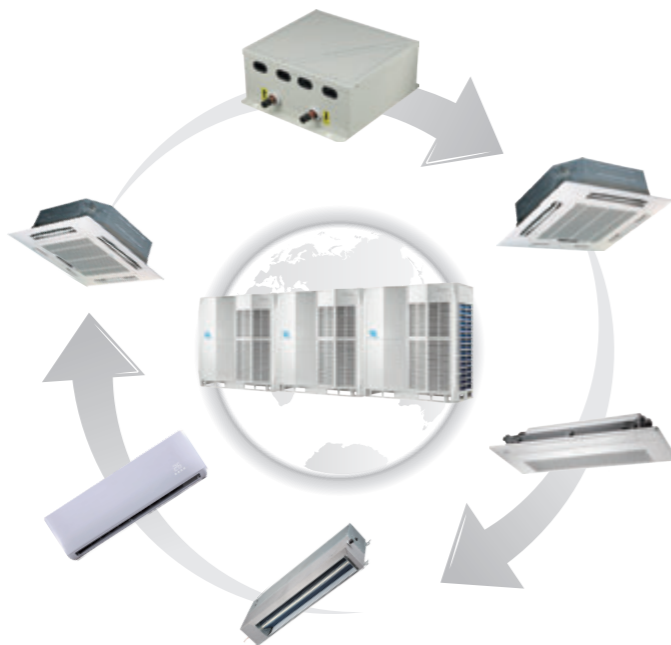

Single AHU Control Box Connection

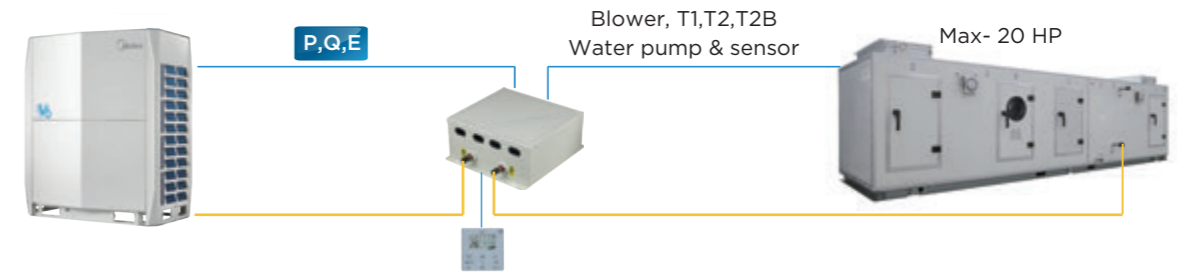

Multi AHU Control Boxes Connection

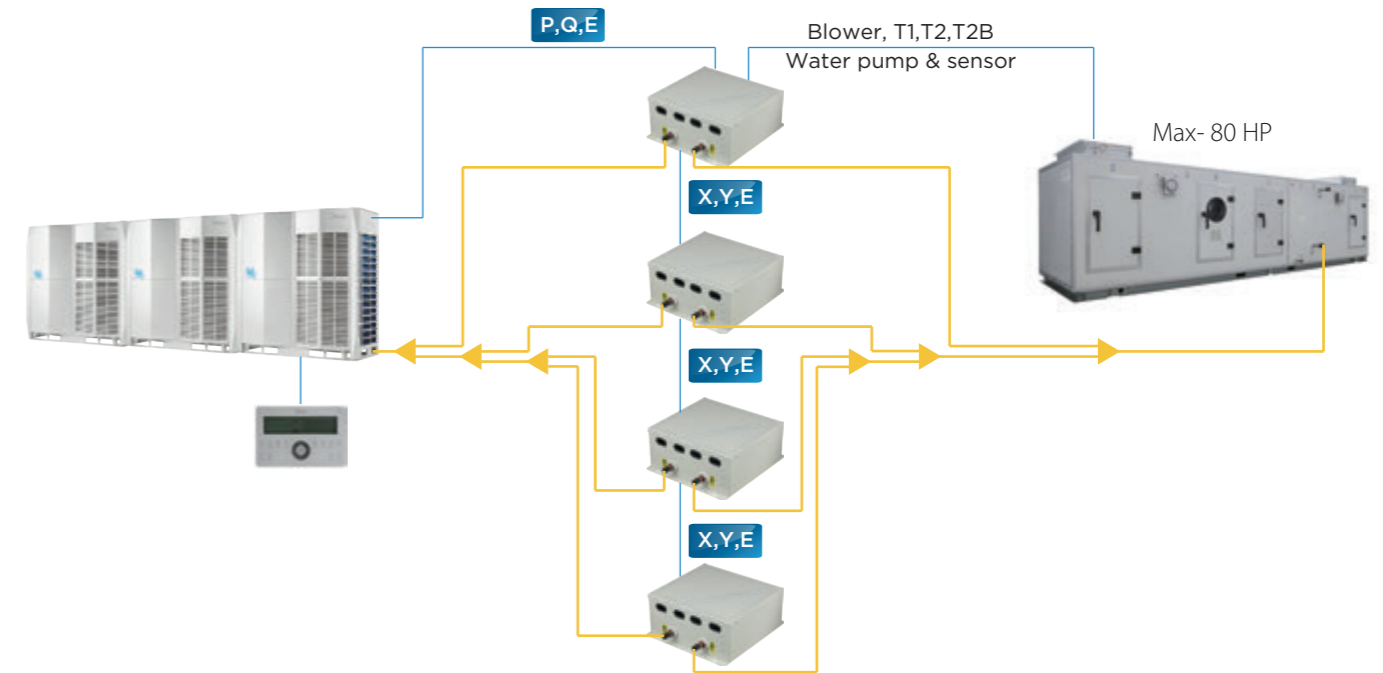

Specifications

Model		AHUKZ-01B	AHUKZ-02B	AHUKZ-03B
Capacity	HP	3.2-6	8-12	14-20
Power supply		1 phase, 220-240V, 50Hz; 1 phase, 208-230V, 60Hz		
Refrigerant		R410A		
Pipe connections (inlet and outlet)	mm	Φ8	Φ12.7	Φ15.9
Net dimensions (W×H×D)	mm	350×150×375		
Packed dimensions (W×H×D)	mm	420×240×490		
Net weight	kg	8.4	8.7	8.9
Gross weight	kg	11.4	11.7	11.9
Operating modes		Cooling, heating and fan only		
Standard controller		Wired controller		
Optional controller		Wireless remote controller; SIEMENS controller		

Selection Software

High Efficiency

Midea's advanced design automation tool can be used by designers, consultants and distributors to greatly reduce the time and effort that must be devoted to the selection process. The software provides quick and convenient selectable options for users, supports multiple languages, and greatly improves the selection process.

The Selection Software provides distributors' sales team with a comprehensive selection of system design reports and calculations. Based on the indoor units, outdoor units and controllers selected, the software produces detailed system layout diagrams and piping requirement calculations.

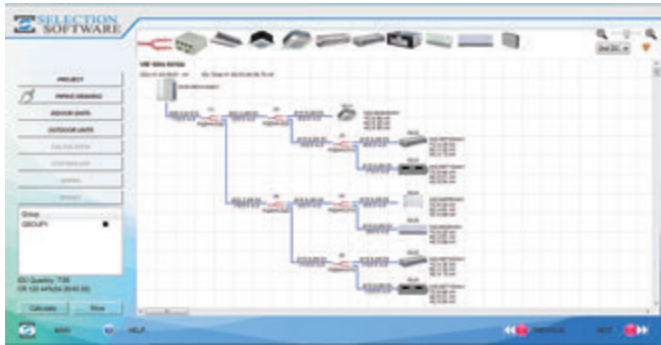

Piping diagram

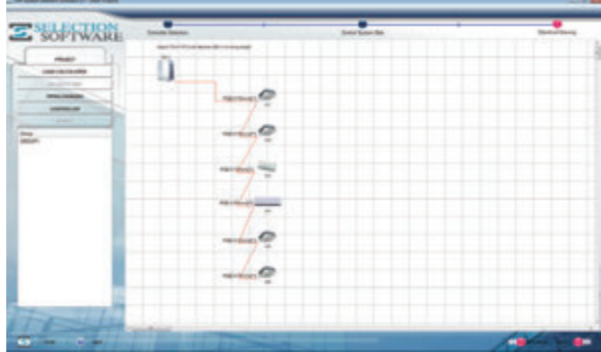

Wiring diagram



Controller selection

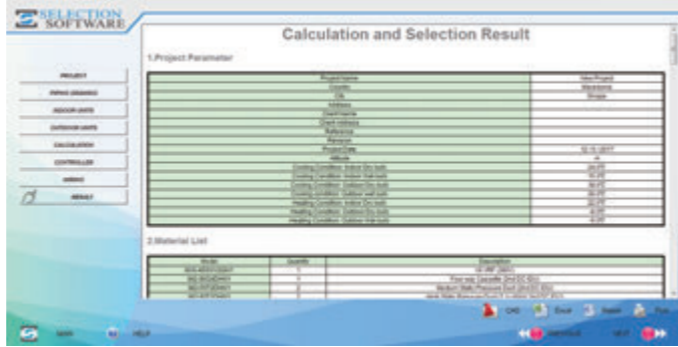

Report

HEAT RECOVERY VENTILATOR

Fan Motor Options

AC and DC fan versions available.

Enhanced Efficiency

The Midea heat recovery ventilator (HRV) can greatly reduce energy losses and room temperature fluctuations caused by the ventilation process. The Midea HRV's strong performance is a result of the advanced technology incorporated into its design. The heat exchanger core is made of specially treated paper which gives enhanced temperature and humidity control. Temperature exchange efficiency is over 65% and enthalpy exchange efficiency is 50-65%.



HRV-200 HRV-500
HRV-300 HRV-800
HRV-400 HRV-1000



HRV-1500
HRV-2000

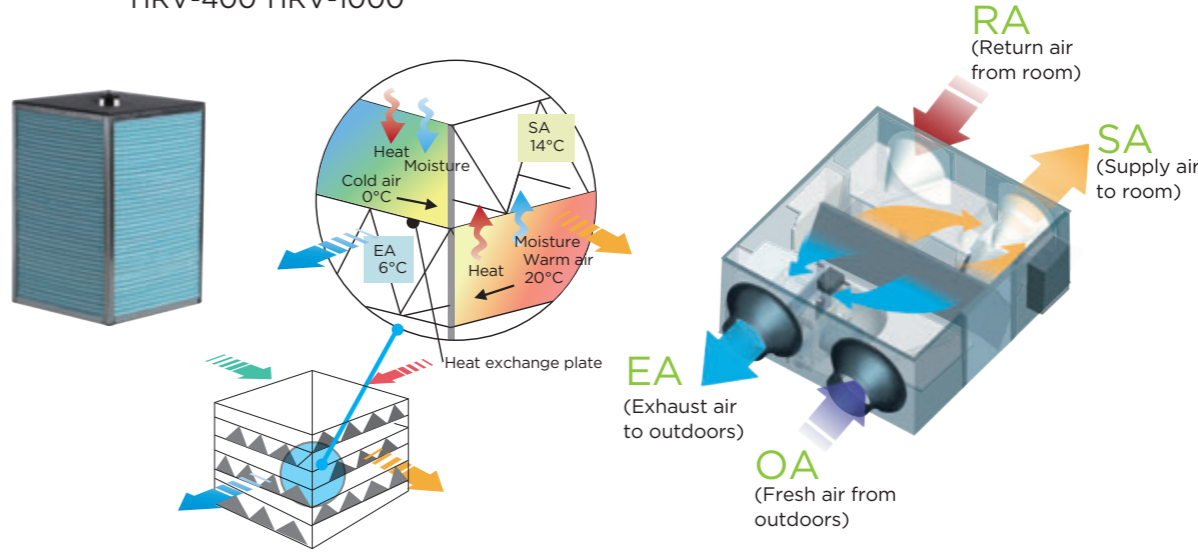

Low Noise

Soundproofing is used to guarantee quiet operation.

Flexibility

Heights starting from as little as 264mm and weights from as little as 23kg mean that the Midea HRV can be easily installed even where space is limited.

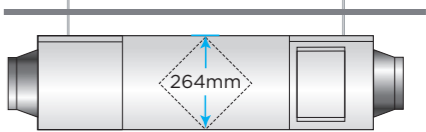

Multiple Modes

Heat exchange mode

The flows of incoming and outgoing air pass close to each other, allowing heat transfer between the two channels. During summer, incoming air is cooled by the indoor air being exhausted and in winter, incoming air is warmed.

Bypass mode

In mild climates or seasons, where temperature and humidity differences between indoors and outdoors are small, the HRV can work as a conventional ventilation fan. In standard bypass mode the supply and exhaust fans run at the same speed.

Air supply mode

Air supply mode is a form of bypass mode where the supply fan is set to run faster than the exhaust fan, which is useful in mild climate installations with high fresh air ventilation requirements.

Exhaust mode

Exhaust mode is a form of bypass mode where the exhaust fan is set to run faster than the supply fan, which is useful in mild climate installations with large amounts of exhaust air to be expelled.

Auto mode

The controller chooses heat exchange mode or bypass mode according to the temperature difference between outdoors and indoors. Both fans are set to run at low speed.

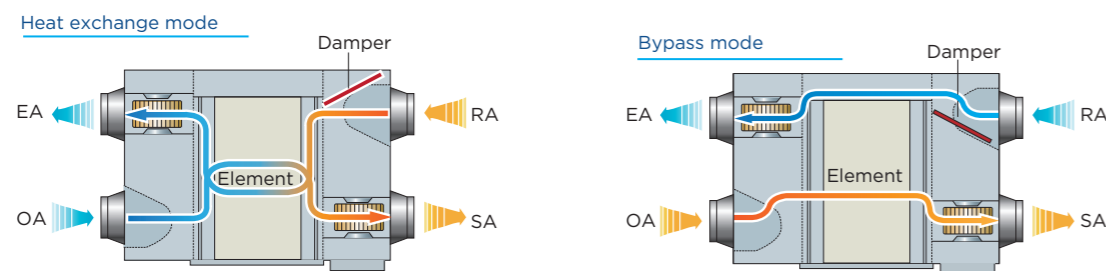

Specifications

AC Series

Model		HRV-200	HRV-300	HRV-400	HRV-500
Power supply	V/Ph/Hz	220-240/1/50		220-240/1/50 & 220/1/60	
Cooling temp. exchange efficiency (H/M/L)	%	55/55/60	55/55/60	55/55/60	55/55/60
Cooling enthalpy exchange efficiency (H/M/L)	%	50/50/55	50/50/55	50/50/55	50/50/55
Heating temp. exchange efficiency (H/M/L)	%	60/60/65	60/60/65	60/60/65	65/65/70
Heating enthalpy exchange efficiency (H/M/L)	%	55/55/60	55/55/60	60/60/65	60/60/65
Sound pressure level in heat exchange mode (H/M/L)	dB(A)	27/26/20	30/29/23	32/31/25	35/34/28
Sound pressure level in bypass mode (H/M/L)	dB(A)	28/27/22	31/30/25	33/32/27	36/35/30
Airflow rate (H/M/L)	m ³ /h	200/200/150	300/300/225	400/400/300	500/500/375
External static pressure (H/M/L)	Pa	75/58/35	75/60/40	80/65/43	80/68/45
Motor type		AC			
Duct diameter	mm	Φ144	Φ144	Φ144	Φ194
Net dimensions (WxDxH)	mm	866×655×264	944×722×270	944×927×270	1038×1026×270
Packed dimensions (WxDxH)	mm	960×770×445	1020×810×452	1020×1020×452	1120×1120×452
Net weight	kg	23	26	31	41
Gross weight	kg	40	44	52	64
Operating temperature range	°C	-7 to 43 DB, RH 80% or lower			

Model		HRV-800	HRV-1000	HRV-1500	HRV-2000
Power supply	V/Ph/Hz	220-240/1/50 & 220/1/60		380-415/3/50 & 220/3/60	
Cooling temp. exchange efficiency (H/M/L)	%	55/55/60	55/55/60	55	55
Cooling enthalpy exchange efficiency (H/M/L)	%	50/50/55	50/50/55	50	50
Heating temp. exchange efficiency (H/M/L)	%	65/65/70	65/65/70	65	65
Heating enthalpy exchange efficiency (H/M/L)	%	60/60/65	60/60/65	60	60
Sound pressure level in heat exchange mode (H/M/L)	dB(A)	39/38/32	40/39/33	51	53
Sound pressure level in bypass mode (H/M/L)	dB(A)	40/39/34	41/40/35	52	54
Airflow rate (H/M/L)	m ³ /h	800/800/600	1000/1000/750	1500	2000
External static pressure (H/M/L)	Pa	100/82/54	100/85/58	160	170
Motor type		AC			
Duct dimensions	mm	Φ242	Φ242	346×326	346×326
Net dimensions (WxDxH)	mm	1286×1006×388	1286×1256×388	1600×1270×540	1650×1470×540
Packed dimensions (WxDxH)	mm	1380×1100×573	1400×1370×573	1710×1410×720	1760×1610×720
Net weight	kg	62	79	163	182
Gross weight	kg	88	110	224	247
Operating temperature range	°C	-7 to 43 DB, RH 80% or lower			

Note:

- Models HRV-200 to HRV-1000 each have 3 airflow settings; the airflow rates of the HRV-1500 and HRV-2000 are not adjustable.
- Sound level is measured 1.4m below the center of the unit in a semi-anechoic chamber.
- Efficiency is measured under the following conditions:
Cooling: exhaust air temp 27°C DB, 19.5°C WB; fresh air temp. 35°C DB, 28°C WB.
Heating: exhaust air temp 21°C DB, 13°C WB; fresh air temp. 5°C DB, 2°C WB.

Specifications



DC Series

Model		HRV-D200	HRV-D300	HRV-D400	HRV-D500
Power supply	V/Ph/Hz	220-240/1/50(60)			
Cooling temp. exchange efficiency	%	76.1	74.8	76.2	76.1
Cooling enthalpy exchange efficiency	%	77.3	76.1	78.7	78.2
Heating temp. exchange efficiency	%	76.1	74.8	76.2	76.1
Heating enthalpy exchange efficiency	%	82.6	79.8	83.6	80.4
Sound pressure level	dB(A)	27	30	32	35
Airflow rate	m ³ /h	200	300	400	500
External static pressure	Pa	75	75	80	80
Motor type		DC			
Duct diameter	mm	Φ144	Φ144	Φ144	Φ194
Net dimensions (WxDxH)	mm	852×665×264	928×734×270	928×940×270	1020×1036×270
Packed dimensions (WxDxH)	mm	910×710×430	980×774×435	1010×1010×440	1120×1120×452
Net weight	kg	25	27	32	35
Gross weight	kg	37	40	46	51
Operating temperature range	°C	-7 to 43 DB, RH 80% or lower			

Model		HRV-D800	HRV-D1000	HRV-D1500	HRV-D2000
Power supply	V/Ph/Hz	220-240/1/50(60)			
Cooling temp. exchange efficiency	%	76.9	75.8	77.8	77.2
Cooling enthalpy exchange efficiency	%	78.1	76.9	79.2	78.7
Heating temp. exchange efficiency	%	76.9	75.8	77.8	77.2
Heating enthalpy exchange efficiency	%	80.1	78.6	80.5	80.3
Sound pressure level	dB(A)	39	40	51	53
Airflow rate	m ³ /h	800	1000	1500	2000
External static pressure	Pa	100	100	160	170
Motor type		DC			
Duct dimensions	mm	Φ242	Φ242	346×326	346×326
Net dimensions (WxDxH)	mm	1276×1020×388	1276×1269×388	1600×1270×540	1650×1470×540
Packed dimensions (WxDxH)	mm	1355×1045×560	1400×1370×573	1710×1410×720	1760×1610×720
Net weight	kg	58	69	151	165
Gross weight	kg	77	90	184	198
Operating temperature range	°C	-7 to 43 DB, RH 80% or lower			

Note:
 1. All models each have have 3 airflow setting.
 2. Sound level is measured 1.4m below the center of the unit in an semi-anechoic chamber.
 3. Efficiency is measured under the following conditions:
 Cooling: exhaust air temp 27°C DB, 19.5°C WB; fresh air temp. 35°C DB, 28°C WB.
 Heating: exhaust air temp 21°C DB, 13°C WB; fresh air temp. 5°C DB, 2°C WB.

BRANCH JOINTS

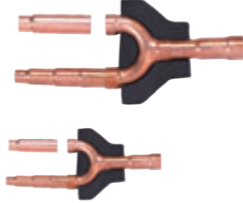
Type	Appearance	Model	Packed Dimensions mm	Gross Weight kg	Note
Branch joints for outdoor units		FQZHW-02N1E	255×150×185	2.0	Connecting two outdoor units
		FQZHW-03N1E	345×160×285	4.3	Connecting three outdoor units
Branch joints for indoor units		FQZHN-01D	290×105×100	0.4	/
		FQZHN-02D	290×105×100	0.6	/
		FQZHN-03D	310×130×125	0.9	/
		FQZHN-04D	350×180×170	1.5	/
		FQZHN-05D	365×195×215	1.9	/
		FQZHN-06D	390×230×255	3.1	/
		FQZHN-07D	390×230×255	3.4	/

Dimensions

Outdoor Branch Joints

Model	Gas side joints	Liquid side joints
FQZHW-02N1E		
FQZHW-03N1E		

Dimensions

Indoor Branch Joints

Model	Gas side joints	Liquid side joints
FQZHN-01D		
FQZHN-02D		
FQZHN-03D		
FQZHN-04D		
FQZHN-05D		
FQZHN-06D		
FQZHN-07D		